

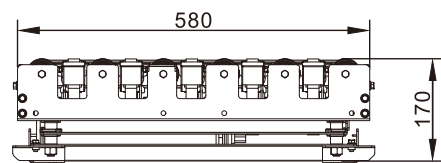

More Easy, More Safe, More Efficiency.

90° Pop-up Conveyor

Structures & Dimensions

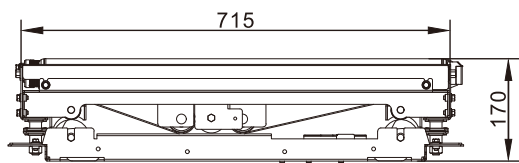
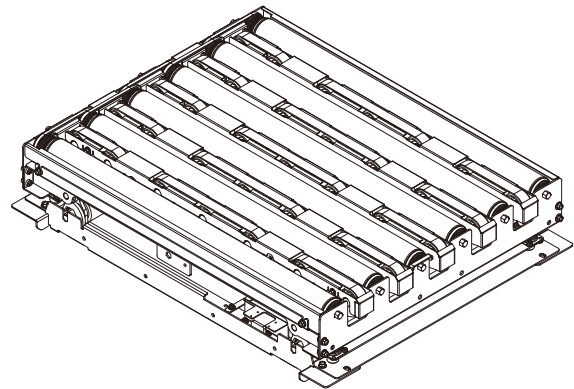
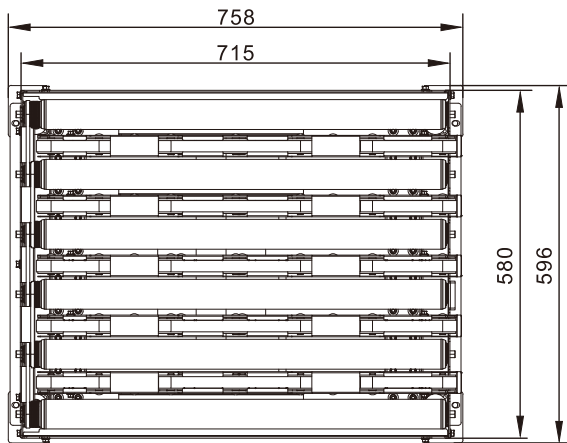

Remark: The above is for dimensions of C600 type.

Technical Data

90° Pop-up Conveyor Specification	Model	Products size to handle	Machine installation size	Suitable for conveyor width	Effective width of roller conveyor
	A400	W380×L715 mm	W396×L758 mm		400-450 mm
	B500	W480×L715 mm	W496×L758 mm		500-550 mm
	C600	W580×L715 mm	W596×L758 mm		600-650 mm
	D700	W680×L715 mm	W696×L758 mm		700-850 mm
Machine height				170 mm	
Run speed				≤60 m/min	
Minimum product size to handle				250×250 mm	
Rated capacity				≤50 kg	
Throughput				1200-1600 packages / hour	
Convey method				DC driven roller	
Pop-up method				DC driven roller	
Output signal type				PNP / NPN	

Applications

Application scenario 1

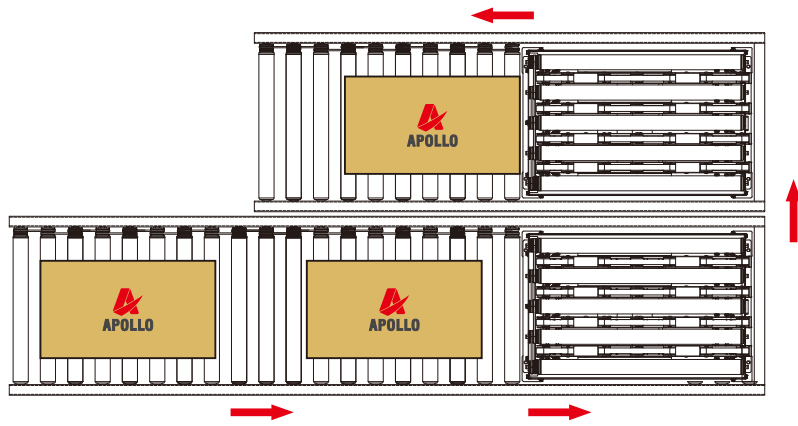

Application scenario 2

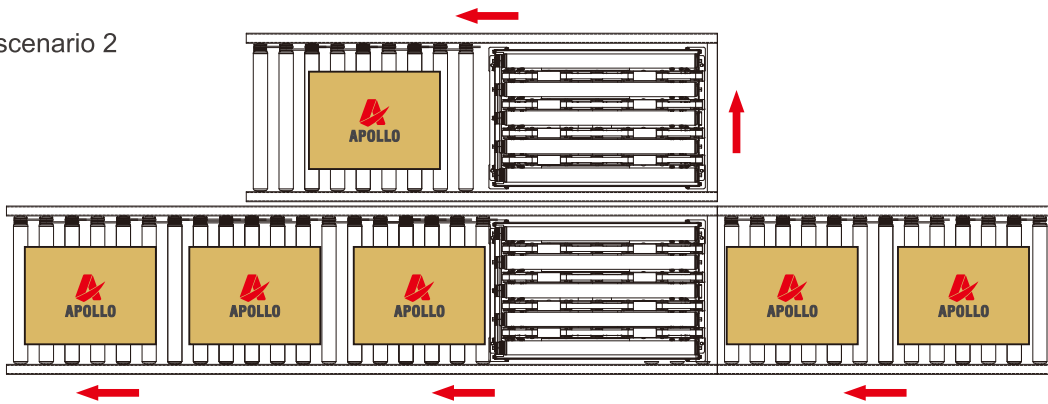

Application scenario 3

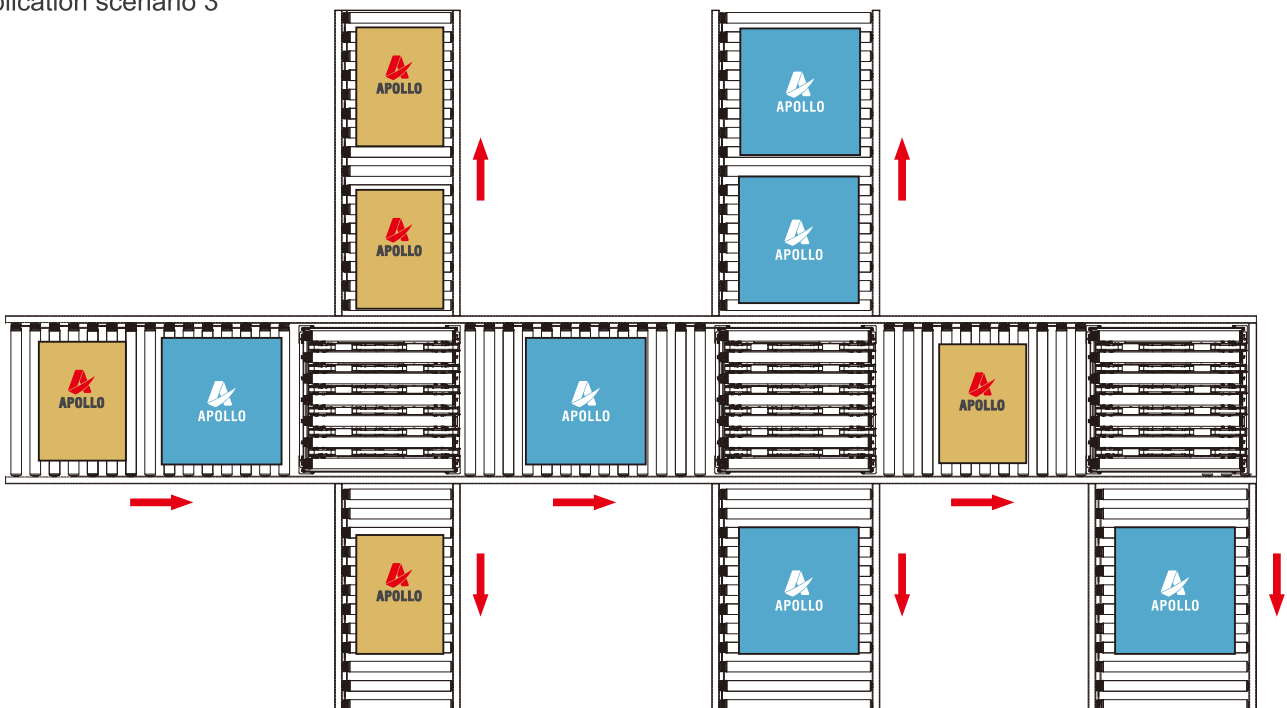

90° Pop-up Conveyor



Features :

Wide adaptability, easy installation, strong control, high safety, maintenance-free, low failure.

APOLLO 90° Pop-up Conveyor gets higher cost performance.

APOLLO 90° Pop-up Conveyor realizes the gentle transport for goods, widely used in various fields in sorting and conveying. Through the modular and standardized design, it can be integrated into most of conveyor lines.

APOLLO 90° Pop-up Conveyor provides a low impact, high performance steering delivery with damage-free to materials. With high fatigue strength and long service life, it is the ideal right-angle transfer for small or medium-sized sorting sites.

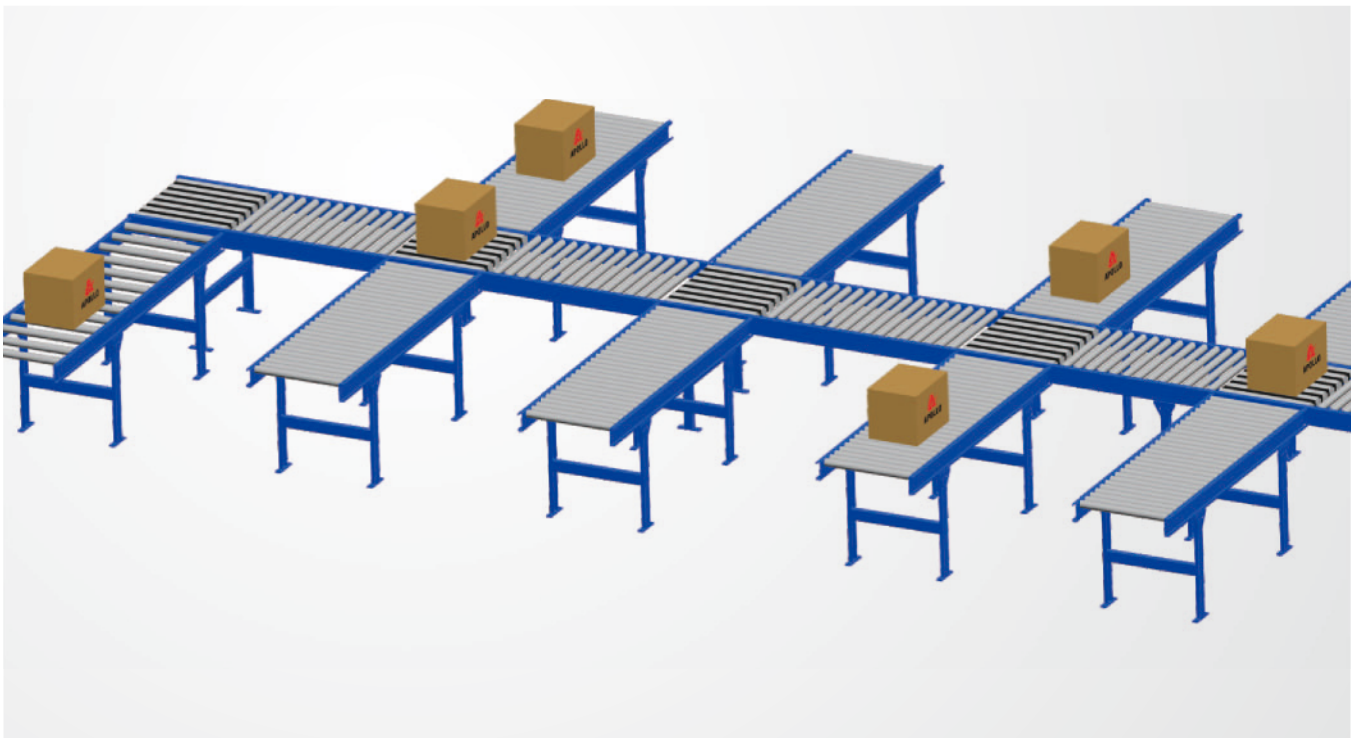





APOLLO MEDIA CENTER

You can find more from our website:

- Rich resource media center and selection guide on how to choose APOLLO products.
- Application reports from different industries cover a variety of operational possibilities.
- Quick product survey and contact information of our system consultants.

www.sz-apollo.com



WeChat
consultation



WeChat public
account

✉ amy@sz-apollo.com



+86-512-6569 8859



+86-151 5140 8535 Amy



No. 5527 Wuzhong avenue, Wuzhong dist, Suzhou, China