

# APOLLO

---

Your Trusted Partner











Professional manufacturer of Intelligent Storage,  
Automatic Sorter, Vertical Lifter and Logistics Conveyor



# Product Brochure

What are you looking for ?

# APOLLO Product Catalog

Product Name	Product Photo	Product Features	Page
<p>Spiral Conveyor</p> 		<ul style="list-style-type: none"> <li>● Equipment material: aluminum alloy column, carbon steel or stainless steel</li> <li>● Equipment height: ≤11m for single unit, ≤40m if multiple units docking</li> <li>● Slat width: 500 / 650 / 900mm</li> <li>● Efficiency: 2000-4000 products/hour</li> <li>● Conveying products: cartons / turnover boxes / woven bags, etc.</li> </ul>	P.07 - 16
<p>Rotative Lifter</p> 		<ul style="list-style-type: none"> <li>● Main structure: Aluminum alloy column</li> <li>● Equipment Height: ≤60m</li> <li>● In and out process: one in and one out; one in and multiple outs; multiple in and multiple outs</li> <li>● Efficiency: 650-1000 products/hour</li> <li>● Conveying products: cartons / turnover boxes, etc.</li> </ul>	P.17 - 21
<p>Reciprocating Lifter</p> 		<ul style="list-style-type: none"> <li>● Equipment height: ≤50m</li> <li>● Equipment load: ≤50kg/product (light type) ≤200kg/product (medium type) ≤500kg/product (heavy type)</li> <li>● Efficiency: 200-500 products/hour</li> <li>● Conveying products: cartons / turnover boxes, etc.</li> </ul>	P.22 - 26
<p>Continuous Lifter</p>		<ul style="list-style-type: none"> <li>● Equipment material: carbon steel / stainless steel</li> <li>● Equipment height: ≤30m</li> <li>● Equipment type: Z type, C type</li> <li>● Efficiency: 700-1400 products/hour</li> <li>● Equipment load: ≤50kg/product (light type) ≤200kg/product (medium type) ≤500kg/product (heavy type)</li> </ul>	P.27 - 29
<p>Pallet Lifter</p>		<ul style="list-style-type: none"> <li>● Equipment material: carbon steel</li> <li>● Equipment height: ≤60m</li> <li>● Equipment load: ≤1000kg (light type) ≤2000kg (medium type) ≤3000kg (heavy type)</li> <li>● Efficiency: 60-100 pallets/hour</li> </ul>	P.30 - 34

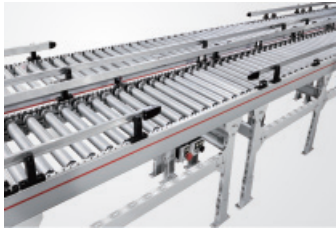

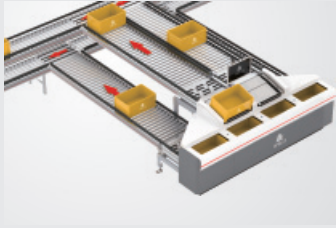
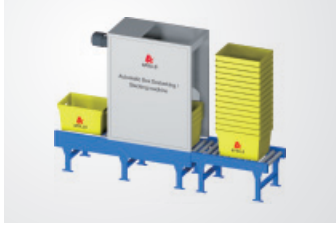
# APOLLO Product Catalog

Product Name	Product Photo	Product Features	Page
<p>Logistics Conveyor</p>		<ul style="list-style-type: none"> <li>● Equipment type: Roller type, Belt type</li> <li>● Equipment material: carbon steel, stainless steel</li> <li>● Drive mode: Roller Drive, Reduction motor</li> <li>● Equipment specifications: customized</li> </ul>	P.35 - 38
<p>Pop-up Transfer</p> <p>👍</p>		<ul style="list-style-type: none"> <li>● Applicable scope: 400-800mm wide roller conveyor line</li> <li>● Main function: 90 degree turn or right angle sorting</li> <li>● Transfer efficiency: ≤1800 products/hour</li> <li>● Conveying products: cartons / turnover boxes, etc.</li> <li>● Installation method: inserted type, equip support legs</li> </ul>	P.39 - 46
<p>Pop-up Diverter</p> <p>👍</p>		<ul style="list-style-type: none"> <li>● Applicable scope: 400-800mm wide roller conveyor line</li> <li>● Diversion efficiency: ≤2400 products/hour</li> <li>● Driving mode: Roller Drive</li> <li>● Conveying products: cartons / turnover boxes, etc.</li> <li>● Installation method: embedded hanging, equip support legs</li> </ul>	P.47 - 49
<p>Picking Station</p>		<ul style="list-style-type: none"> <li>● Equipment material: Carbon steel powder coated</li> <li>● Main function: Goods-to-person picking</li> <li>● Picking efficiency: ≤600 boxes/hour</li> <li>● Product advantages: ergonomic and high picking efficiency</li> </ul>	P.50 - 52
<p>Automatic Box Destacking / Stacking machine</p> <p>👍</p>		<ul style="list-style-type: none"> <li>● Number of layers: 2-20 boxes/stack</li> <li>● Destacking / Stacking efficiency: 500-800 products/hour</li> <li>● Action mechanism: Full servo mechanism (no air supply)</li> <li>● Conveying products: Standard turnover box / plastic basket</li> <li>● Dimensions: L1800×W600×H1800mm (suitable for 600×400×300 material boxes)</li> </ul>	P.53 - 54

# APOLLO Product Catalog

Product Name	Product Photo	Product Features	Page
<p>Telescopic Belt Conveyor</p> <p>👍</p>		<ul style="list-style-type: none"> <li>● Equipment type: fixed, movable</li> <li>● Equipment function: easy loading and unloading</li> <li>● Suitable for: 6.8m, 9.6m, 20/40ft container, 13m, 17.5m trucks</li> <li>● Loading and unloading efficiency: 1000-2000 products/hour</li> </ul>	P.55 - 61
<p>Flexible Roller Conveyor</p>		<ul style="list-style-type: none"> <li>● Roller material: galvanized carbon steel, 304 stainless steel</li> <li>● Equipment function: transportation of goods in the warehouse</li> <li>● Product advantages: flexible and easy to move</li> <li>● Equipment power: single-phase 220V, three-phase 380V</li> </ul>	P.62 - 64
<p>Mobile Loading Conveyor</p>		<ul style="list-style-type: none"> <li>● Usage: portable mobile</li> <li>● Extendable length: 6m into the truck</li> <li>● Suitable models: 20ft container / 6.8m, 9.6m and other small or medium-sized trucks</li> </ul>	P.65 - 66
<p>Sliding Shoe Sorter</p> <p>👍</p>		<ul style="list-style-type: none"> <li>● Equipment type: single-sided, double-sided sorting</li> <li>● Sorting efficiency: 5000-10000 products/hour</li> <li>● Sorting outputs: ≤132 outputs/unit</li> <li>● Sorting goods: cartons, turnover boxes, plastic baskets, tires, large parcels, etc.</li> <li>● Product advantages: can sort large, long, heavy and special-shaped items</li> </ul>	P.67 - 74
<p>Steerable Wheel Sorter</p>		<ul style="list-style-type: none"> <li>● Equipment type: single-sided, double-sided sorting</li> <li>● Sorting efficiency: 2000-4000 products/hour</li> <li>● Sorting products: cartons, turnover boxes, plastic baskets, etc. (the bottom of the goods must be flat)</li> </ul>	P.75 - 77

# APOLLO Product Catalog

Product Name	Product Photo	Product Features	Page
<p>Pop-up Sorter</p>		<ul style="list-style-type: none"> <li>● Equipment type: single-sided, double-sided sorting</li> <li>● Sorting efficiency: ≤2000 products/hour</li> <li>● Sorting products: cartons, turnover boxes, plastic baskets, etc. (the bottom of the goods must be flat)</li> </ul>	<p>P.78 - 79</p>
<p>Mini Picking Sliding Shoe Sorter</p>		<ul style="list-style-type: none"> <li>● Equipment type: single-sided, double-sided sorting</li> <li>● Sorting efficiency: ≤5000 products/hour</li> <li>● Sorting outputs: ≤240 outputs/unit</li> <li>● Sorting products: can sort small products of 50-300mm</li> <li>● Picking goods: small cartons, books, fresh food, snacks, condiments, cylindrical packaged goods, etc.</li> </ul>	<p>P.80 - 82</p>
<p>More APOLLO products</p>	<p style="text-align: center;">. . .</p>	<p style="text-align: center;">Coming soon</p>	<p style="text-align: center;">. . .</p>

# Spiral Conveyor



Product introduction:  
See P.07-16 for details



Scan QR code on WeChat to  
watch video

## Selection parameters of APOLLO spiral conveyor (logistics type)

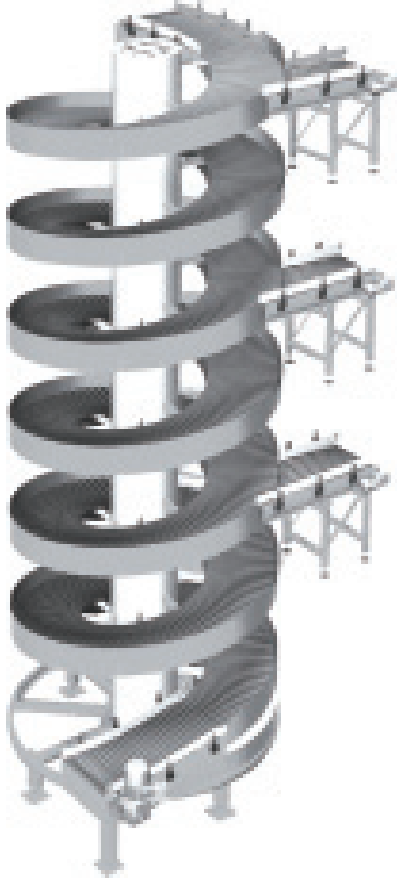

**Suitable for heavy goods up to 50kg, 7×24h operation and speed up to 60m/min with stable running.**

The vertical conveying capacity of spiral conveyor is faster and more reliable than other forms of conveyors or lifters.

APOLLO Spiral Conveyor adopts modular design, multiple specifications are available to meet different size of goods. It is suitable for vertical transportation for cartons, plastic totes and partial woven bags etc.

APOLLO Spiral Conveyor uses low friction slat and rolling friction bearing, which has the characteristics of low wear and low noise.

APOLLO Spiral Conveyor is widely used in food and beverage, pharmaceutical, fast consumer goods, clothing, electronic products and other industries.

### 1. Machine Advantages

Low friction structure, stable and reliable  
Low noise running, quiet and comfortable

### 2. Safety Protection

Stuck goods/ overload protection  
Automatic chain loosening protection

### 3. Slat

Inserted slat  
Easy to replace

### 4. Chain

Automatically tensioning chain  
By Spring / Pneumatic

### 5. Center column

Aluminum structure, accurate positioning  
Exquisite and beautiful appearance

### 6. Installation and maintenance

Easy installation, deliver in fully assembled or disassembled  
Convenient and fast maintenance

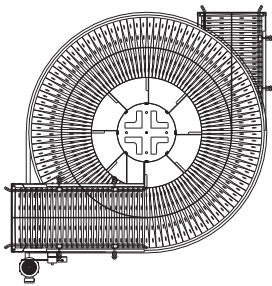

Type A : 90°

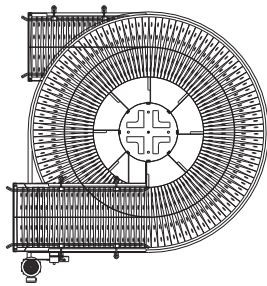

Type B : 180°

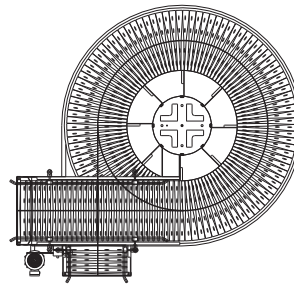

Type C : 270°

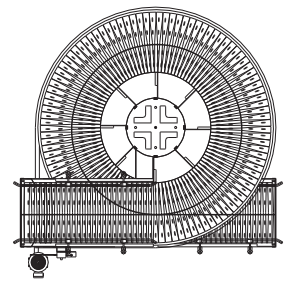

Type D : 360°

Model	Slat width	Abutting conveyor width	Run speed	Rated load	Outer diameter	Equipment height	Equipment material
A-500	500mm	≤580mm	≤60m/min	≤50kg/m	φ 2200mm	≤12m Multiple units can get greater height	Carbon steel (customizable color) Stainless steel 304
A-650	650mm	≤730mm	≤60m/min	≤50kg/m	φ 2550mm	≤12m Multiple units can get greater height	Carbon steel (customizable color) Stainless steel 304
A-900	900mm	≤1000mm	≤60m/min	≤50kg/m	φ 4000mm	≤9m Multiple units can get greater height	Carbon steel (customizable color) Stainless steel 304

Note: The above specifications are APOLLO standard models. If you need other specifications and sizes, please contact our sales.

## Types of APOLLO Spiral Conveyor

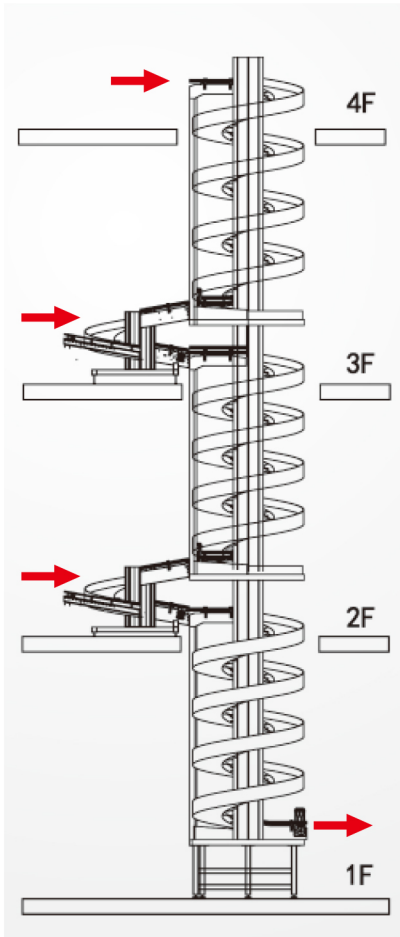

Three infeed One outfeed

- Multiple entrances on different floors
- Multiple units superposition, spiral transportation
- Safe and reliable, easy maintenance
- Effectively reduce the cost of vertical transportation

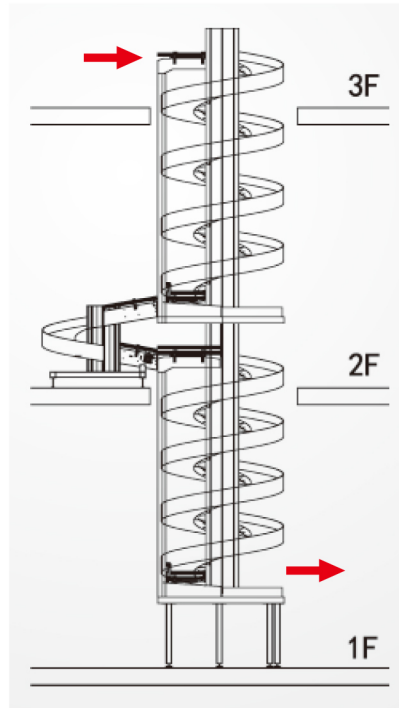

One infeed One outfeed  
(2 units superposition)

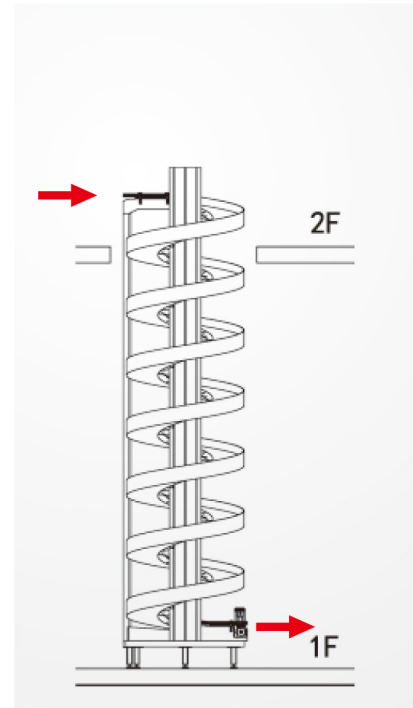

One infeed One outfeed

APOLLO spiral conveyor adopts modular component assembly and plug-in combined slats. The slats are injection molded and have good toughness and strength.

APOLLO spiral conveyor use a unique low-friction guide device structure (high-precision and very low-friction bearings, high-load traction chains, and rolling tracks made of wear-resistant materials).

APOLLO Spiral Conveyor is simple control, stable and reliable operation, easy maintenance and long service life.



# Spiral Conveyor



## Production of APOLLO Spiral Conveyor

Production in factory



Performance test



Commissioning at factory



Transportation



# Spiral Conveyor



## Delivery of APOLLO Spiral Conveyor

### Installation



### Delivery and operation



# Spiral Conveyor



## Application of APOLLO Spiral Conveyor



APOLLO  
Spiral Conveyor

- High efficiency, Small space occupation
- Low noise running, quiet and comfortable
- Max speed 60m/min, Max capacity 50kg/m
- Built-in protection, able to run 7×24 hours



Stainless Steel  
Spiral Conveyor



# Spiral Conveyor



## Application of APOLLO Spiral Conveyor

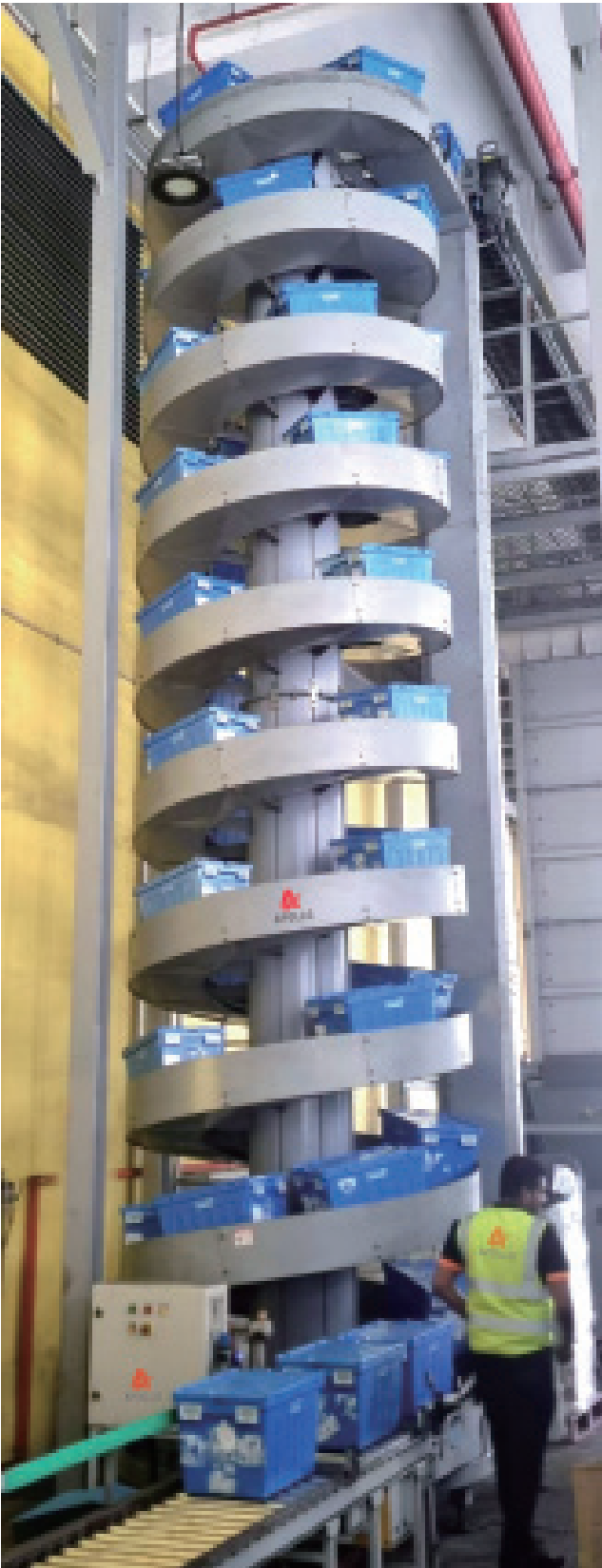

## Application of APOLLO Spiral Conveyor



# Spiral Conveyor



## Application of APOLLO Spiral Conveyor

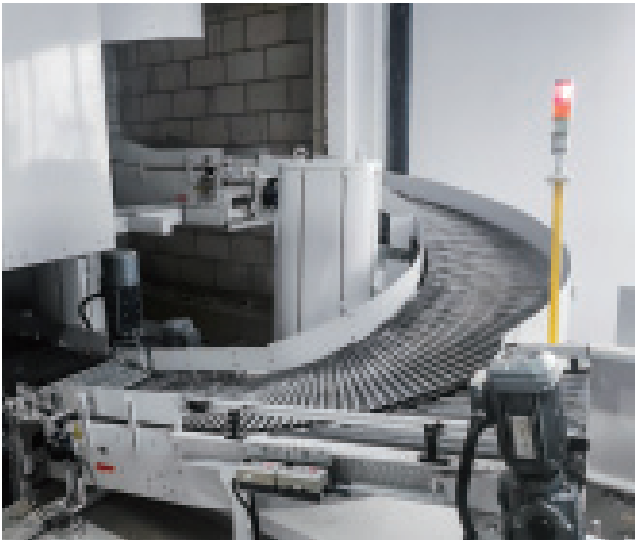

## Application of APOLLO Spiral Conveyor

---



# Rotative Lifter



Product introduction:  
See P.17-21 for details



Scan QR code on WeChat to  
watch video

## Selection parameters of APOLLO Rotative Lifter

APOLLO design and customize different forms of infeed and outfeed conveyors according to the working process in factory, integrate them seamlessly with other delivery systems. Help customers to improve production line efficiency and ensure their material handling needs are met and operation costs are reduced.

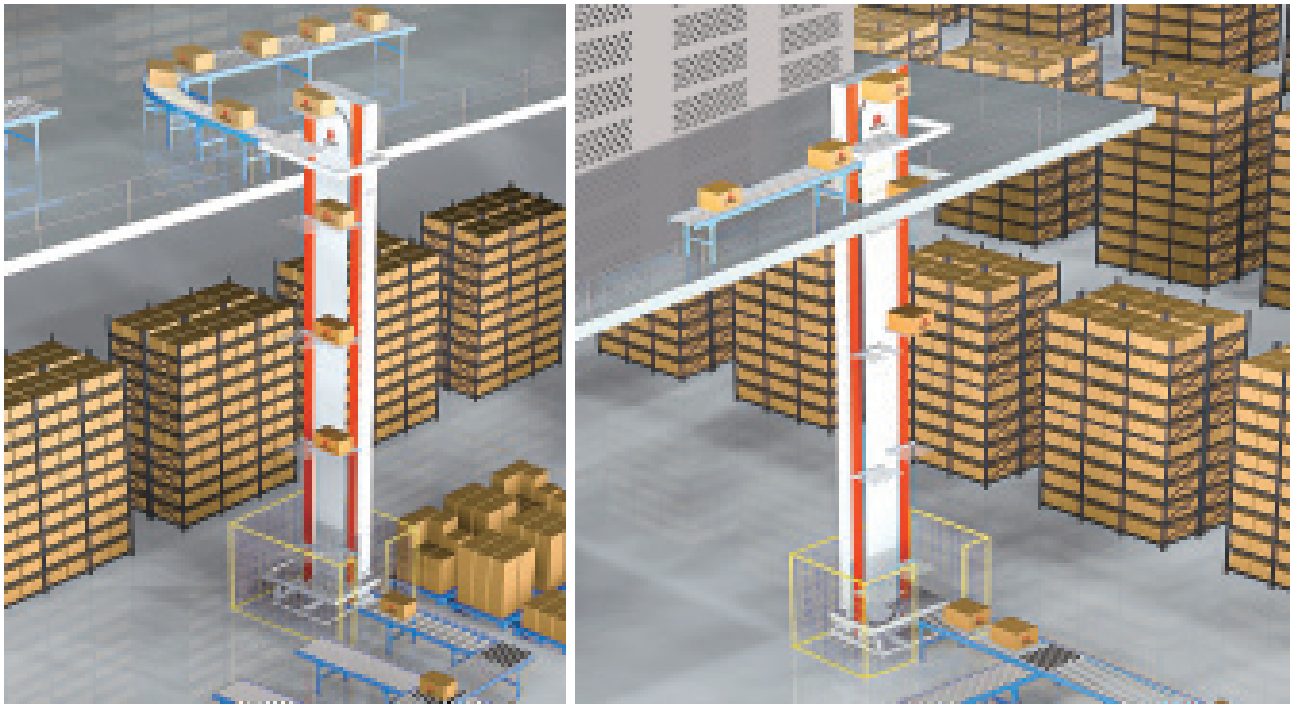

APOLLO Rotative Lifter is suitable for a wide range of products, such as cartons, turntable boxes, crates, plastic totes, bags, drums etc.



Technical Parameters		
Item	XH-1 Standard Type	XH-2 Widened Type
Cargo size	Max : L650×W500×H500mm	Max : L800×W600×H600mm
Main column material	Aluminum Alloy	
Infeed / outfeed type	One in one out / One in multiple out / Multiple in one out / Multiple in multiple out	
Infeed direction	Front / Side infeed	
Outfeed direction	Front / Side outfeed	
Docking with infeed / outfeed conveyor	Traverse docking / Telescopic docking	
Lowest height of infeed outfeed docking	≥750mm	
Maximum height of lifter	≤60m	
Rated load	≤50kg	
Conveying efficiency	650-1000 products/hour	

# Rotative Lifter



## Types of APOLLO Rotative Lifter

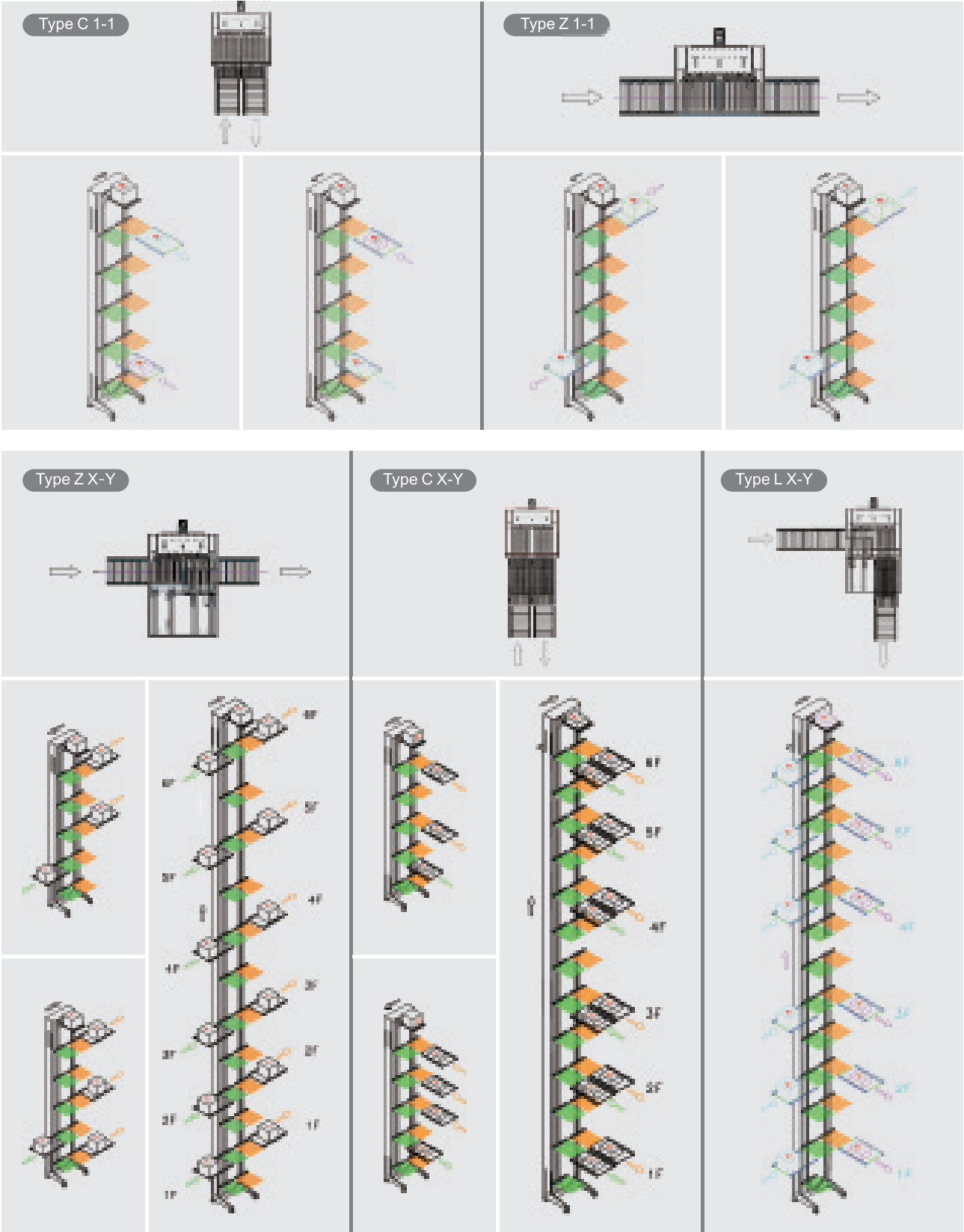

## Types of APOLLO Rotative Lifter

APOLLO can provide customers better logistics solutions with international experience in plant logistics innovation and optimization. Rotative vertical lifter is used for vertical transport and sorting for goods between different floors.

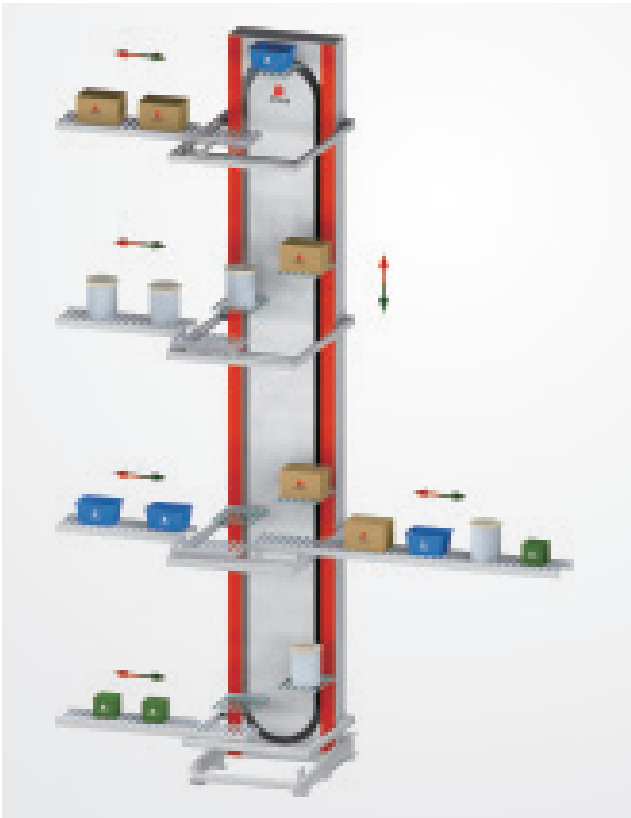

# Rotative Lifter



## Application of APOLLO Rotative Lifter



# Reciprocating Lifter



Product introduction:  
See P.22-26 for details



Scan QR code on WeChat to  
watch video

## Selection parameters of APOLLO Reciprocating Lifter



Parameter name	Low speed type WF-1		Medium speed type WF-2		High-speed type WF-3	
Cargo size	L200-1600mm × W200-800mm × H10-600mm					
Lifting height	≤50 m					
Run speed	< 1.5 m/s		1.5-4 m/s		4-6 m/s	
Rated load	≤50kg/product (light duty)		≤200kg/product (medium duty)		≤500kg/product (heavy duty)	
Lifting efficiency	≤500 products/hour					
Drive mode	Timing belt / chain					
Main column material	Aluminum Alloy					
Infeed/Outfeed direction	Side / Forward					
Cargo platform form	Single layer single station	Single layer double station	Double layer single station	Double layer double station	Three-layer single station	Three-layer double station

Note: If you have special requirements, please contact APOLLO.

## Application of APOLLO high-speed Reciprocating Lifter

Reciprocating Lifter is a kind of discontinuous vertical conveyor, which has the advantages of small occupation, lifting wide range of goods, stable operation and simple maintenance.

APOLLO lifter is driven with silent synchronization belt, which is very quiet during operation. In addition, there is little maintenance of this mechanism, no need lubrication and tension regulation compared to chain-driven structures.

### APOLLO Reciprocating Lifter can be quickly and flexibly integrated into the project system

APOLLO Reciprocating Lifter follows the highly standardized and modular design concept, the main column is the standard aluminum column, the loading platform is roller conveyor with standard configuration. If the transported product has certain particularity, APOLLO can also choose to use belt conveyor or other specific carriers. Due to the small size of the lifter itself, it can be quickly integrated to the conveyor system of production or logistics distribution.

### Wide Application

For the infeed / outfeed direction of Reciprocating Lifter, there are a variety of forms to choose, so the site layout is flexible and convenient. APOLLO Reciprocating Lifter can also dock with multiple infeed or outfeed conveyors to achieve vertical sorting, the components of lifter are highly standardized, low maintenance, it is a very economic and durable vertical sorting conveyor.

Reciprocating lifter is suitable for wide range of products, such as cartons, turnover boxes, cartons, crates, pallets, bags, drums, etc.



## Application of APOLLO Reciprocating Lifter

---



## Application of APOLLO Reciprocating Lifter

---

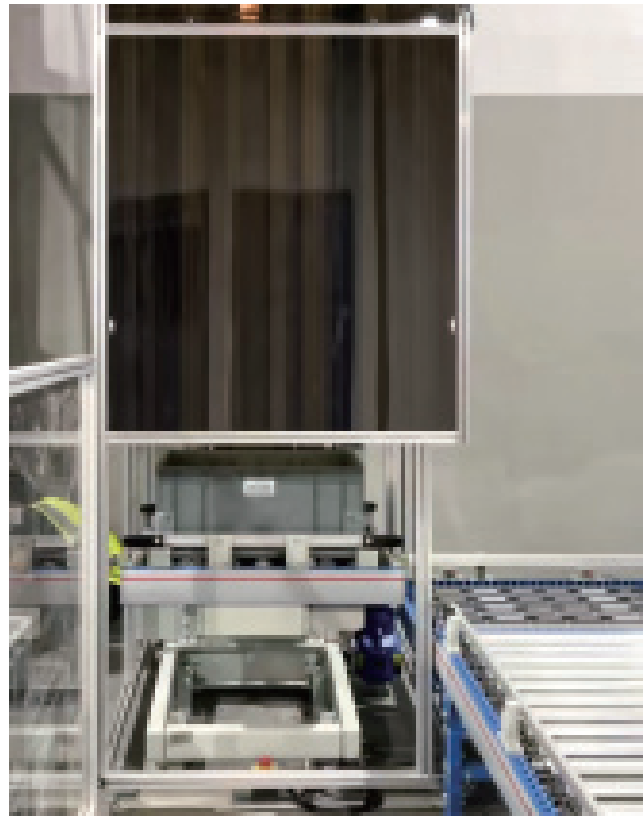

# Continuous Lifter



Product introduction:  
See P.27-29 for details



Scan QR code on WeChat to  
watch video

# Continuous Lifter



## Selection parameters of APOLLO Continuous Lifter

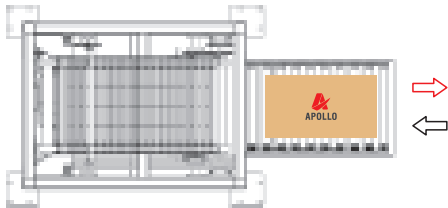
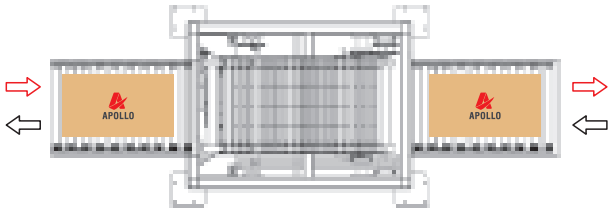
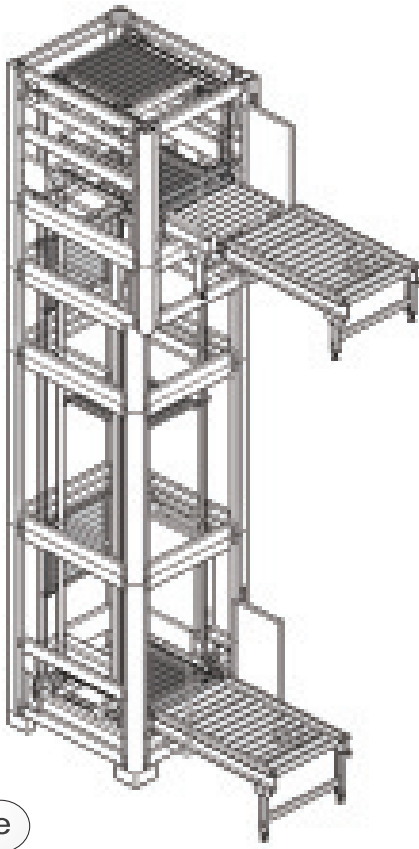
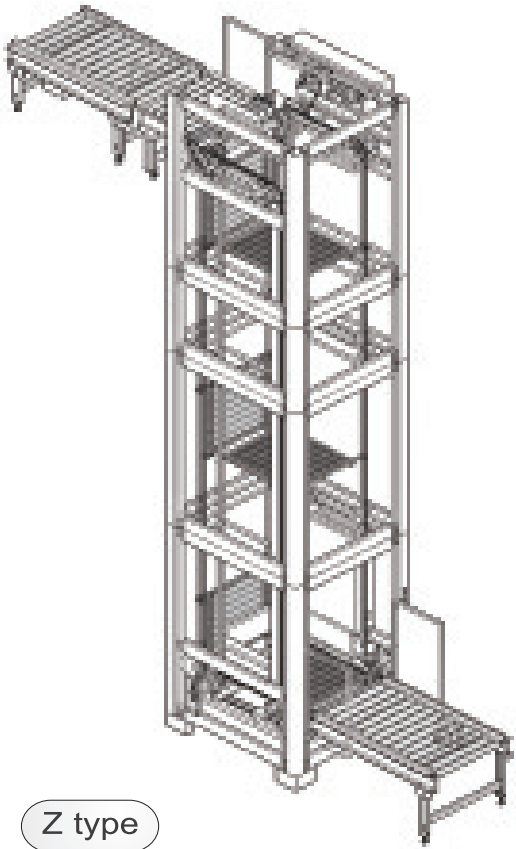

Parameter name	Continuous Lifter		
Vertical conveying form	Z type / C type		
Cargo size	L200-1200mm×W200-1000mm×H20-1000mm		
Lifting height	≤25 m		
Run speed	≤1 m/s		
Rated load	≤50kg(light duty)	≤150kg (medium duty)	≤500kg (Heavy duty)
Lifting efficiency	≤1200 products/hour		
Drive mode	Chain		
Main frame material	Carbon steel / stainless steel		
Outer cover plate	Mesh plate / steel plate / acrylic		

# Continuous Lifter



## Application of APOLLO Continuous Lifter



# Pallet Lifter

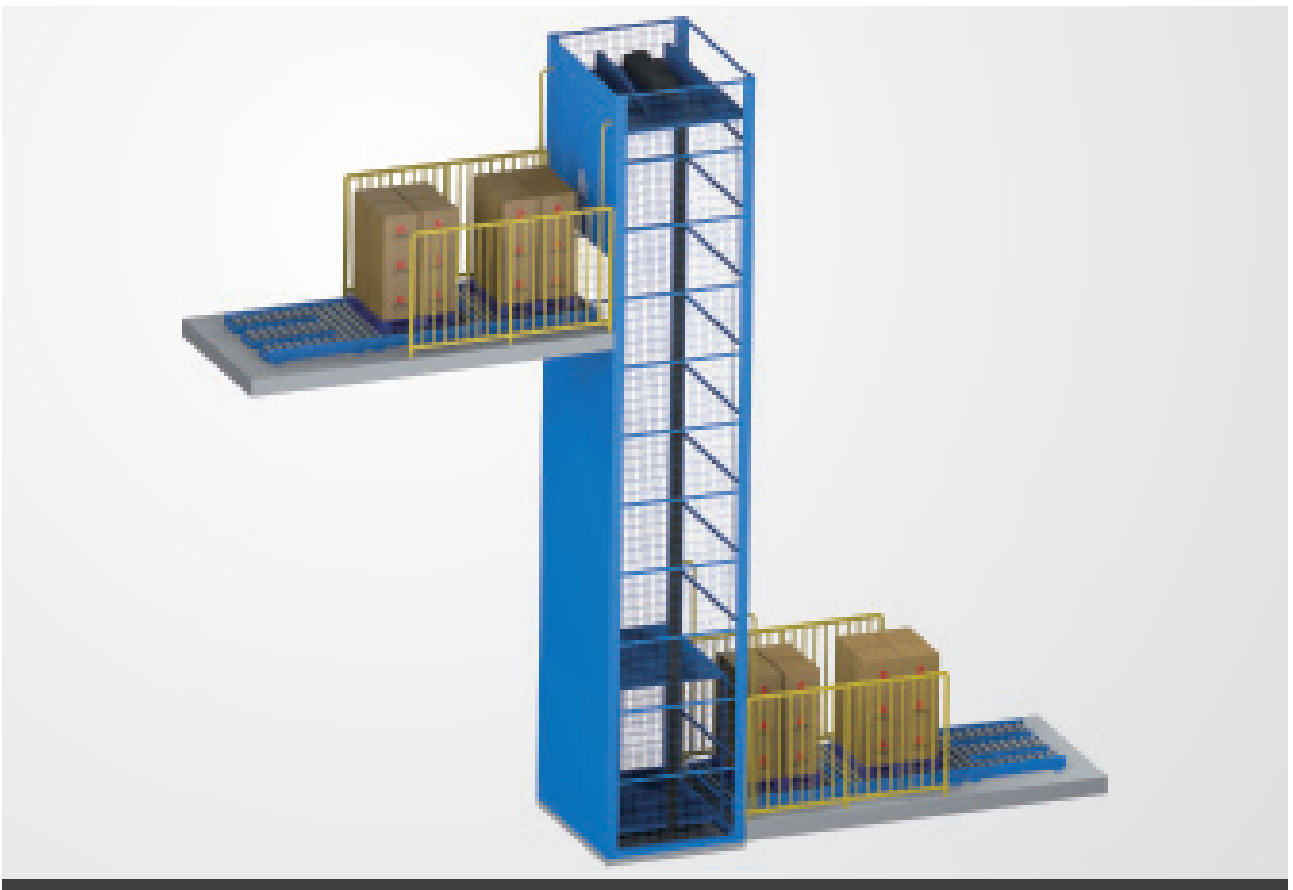

Product introduction:  
See P.30-34 for details



Scan QR code on WeChat to  
watch video

## Application of pallet lifter

Lifter equipment can be combined with an automated control system to transport goods vertically to different floors.

It is widely used in various industries, such as multi-floor transportation in workshops, logistics warehousing and distribution centers, etc. It has the characteristics of high efficiency, high safety, simple operation, easy installation and maintenance, etc.

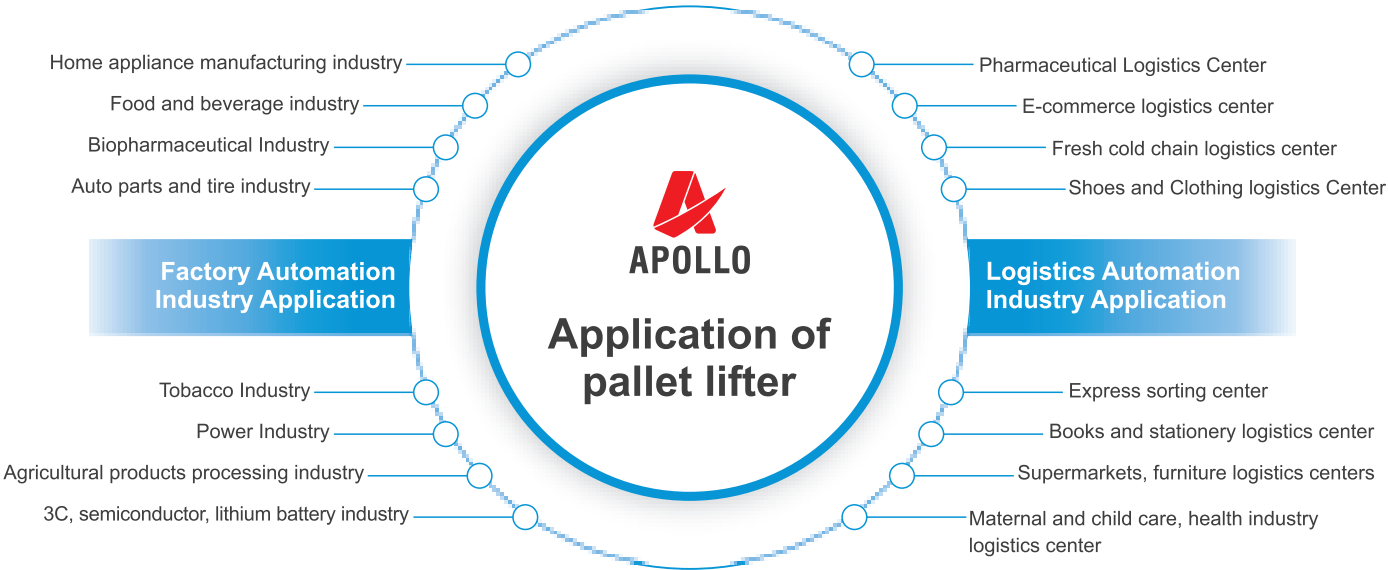

Product advantages of Pallet Lifter	
Installation site	Cargo elevator shaft/ Indoor/ Outdoor
Equipment structure	Modular vertical tower steel structure design, fast and flexible assembly, stable and durable
Stable operation	Adopts variable frequency control to ensure stable acceleration or deceleration, and the goods will not fall over.
Carry capacity	The handling capacity is about 60-100 pallets/hour (about 3 times than cargo elevator)
Run speed	Run speed 60-100m/min, (cargo elevator speed is about 18m-25/min)
Device properties	Non-special equipment, no annual inspection required (cargo elevator is a special equipment, which must be inspected every year)
Automation control	Strong scalability, can be combined with WMS, AGV, four-way vehicles to achieve automatic operation
Maintenance cost	Low maintenance cost, 1-4 regular inspections and maintenance each year depending on usage

### Transport carrier

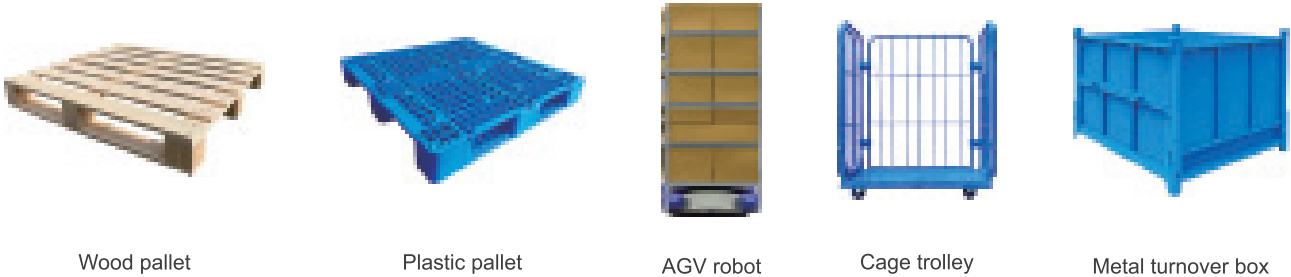

# Pallet Lifter



## Selection parameters of APOLLO Pallet Lifter

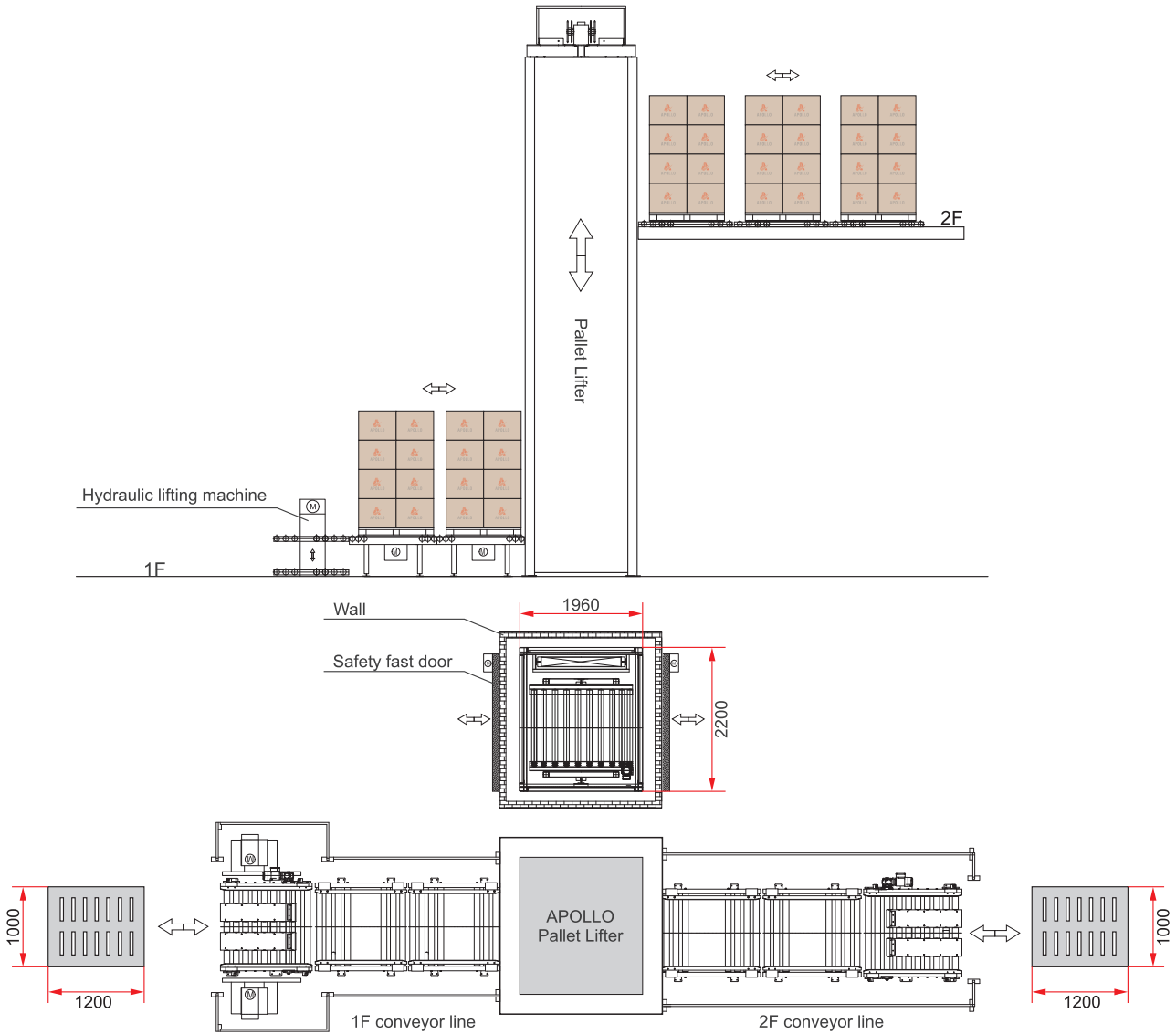

Technical Parameters	
Parameter name	Z type / C type / E type / CC type / EE type
Equipment height	≤60m
Pallet + cargo size	L800-1800mm × W800-1800mm × H100-2500mm
Equipment load	≤1000kg (light type)    ≤2000kg (medium type)    ≤3000kg (heavy type)
Lifting efficiency	60-100 pallets/hour
Lifting speed	≤90m/min
Equipment material	Carbon steel and powder coating
Entrance and exit docking equipment	Roller machine / chain machine / AGV, etc.
Safety package	Appearance inspection door / fast safety door / guard rail etc.

# Pallet Lifter



## Types of APOLLO Pallet Lifter

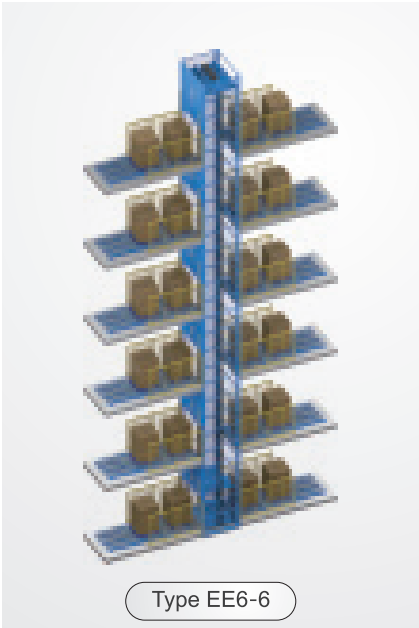
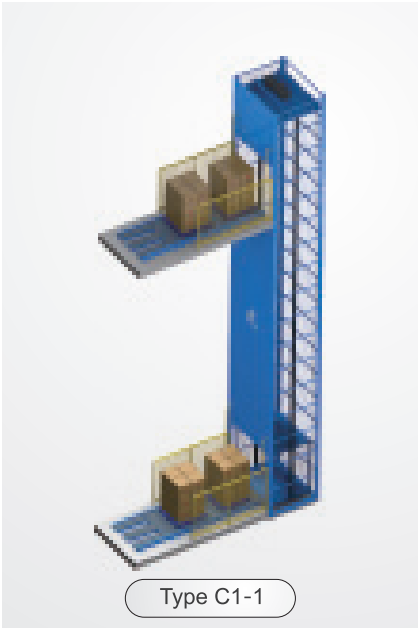

### Type of entrance and exit equipment



Hydraulic truck handling + connecting lifting machine (without pit)

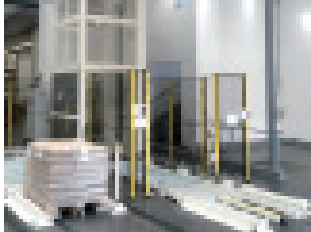

Hydraulic truck transportation (with pit)



AGV, mobile vehicle and other transportation (with pit)

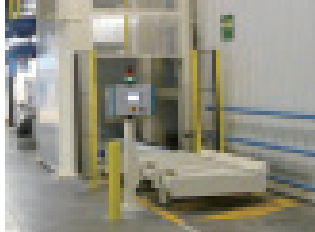

Forklift handling (without pit)

## Application of APOLLO Four-way Shuttle Pallet Lifter

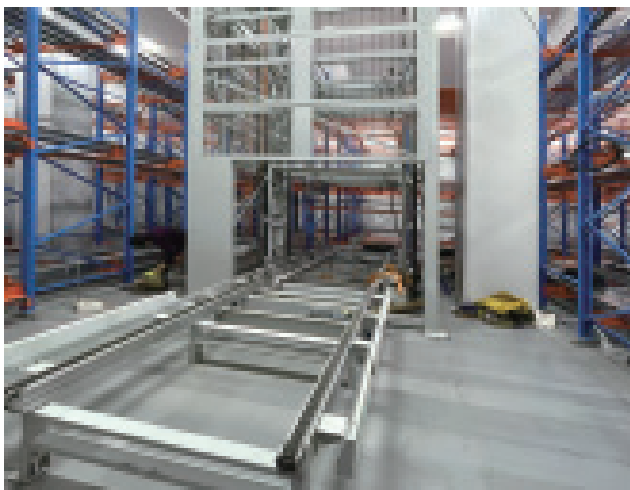
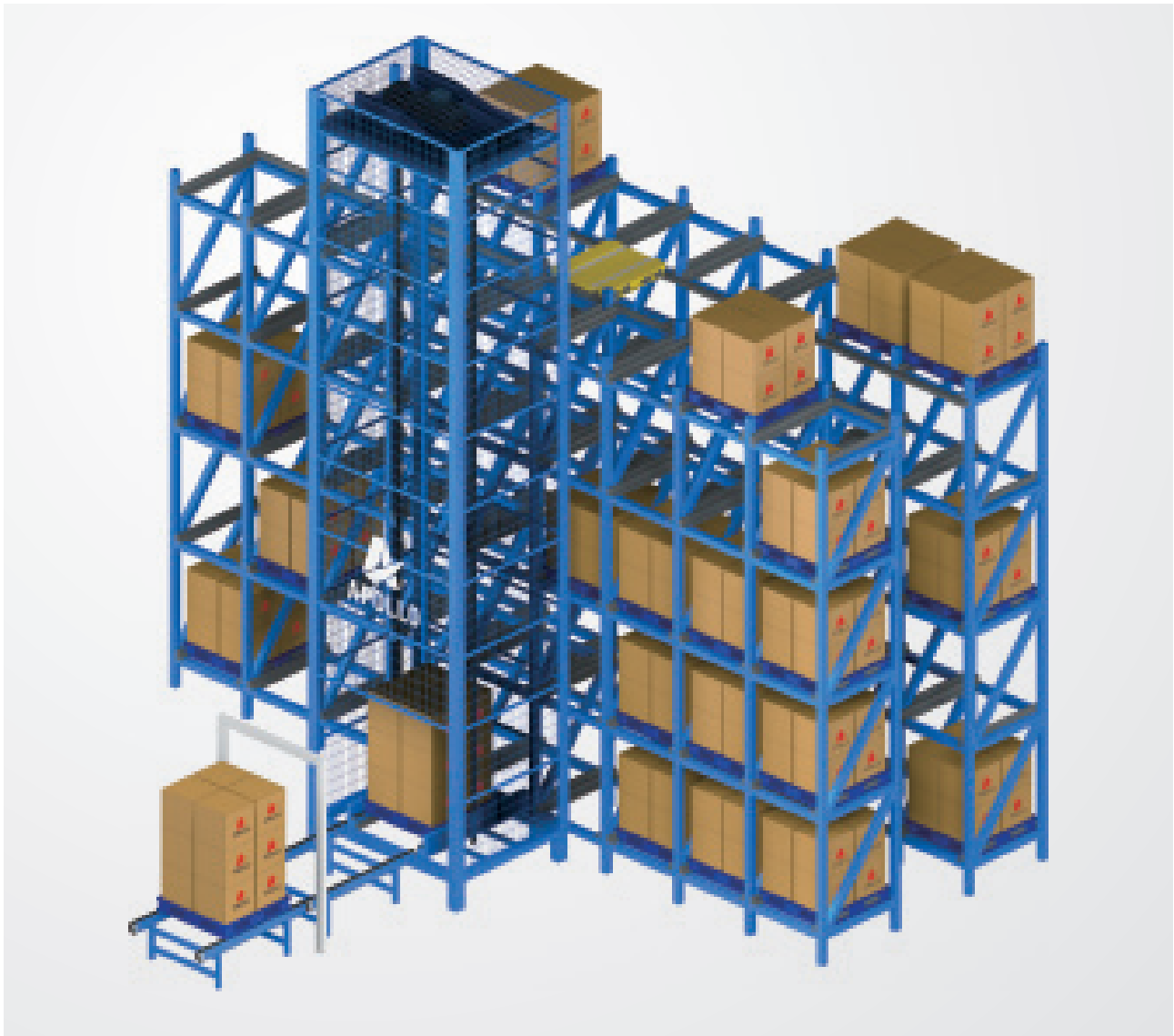

# Logistics Conveyor



Product introduction:  
See P.35-38 for details



Scan QR code on WeChat to  
watch video

# Application of APOLLO Roller Conveyor

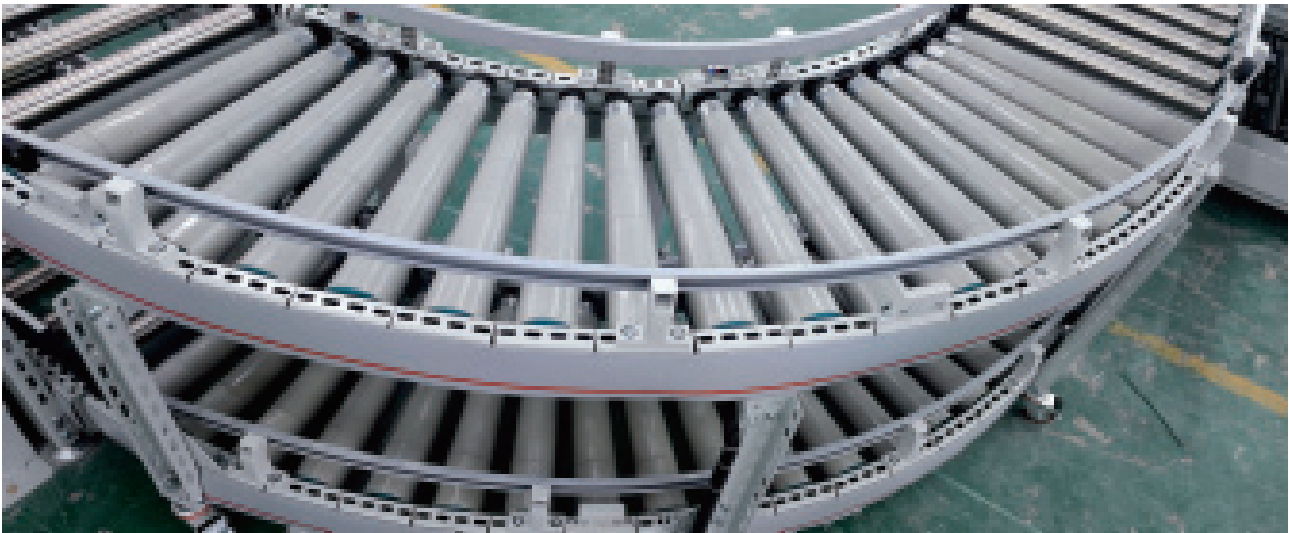
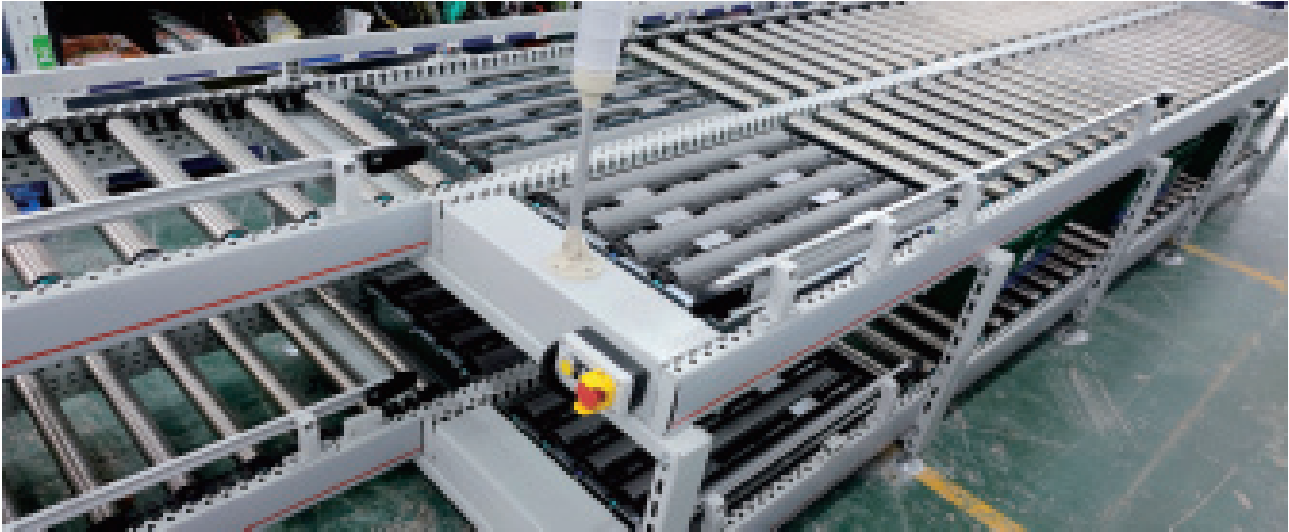

# Standard configuration of APOLLO Roller Conveyor

Application: Sorting and conveying

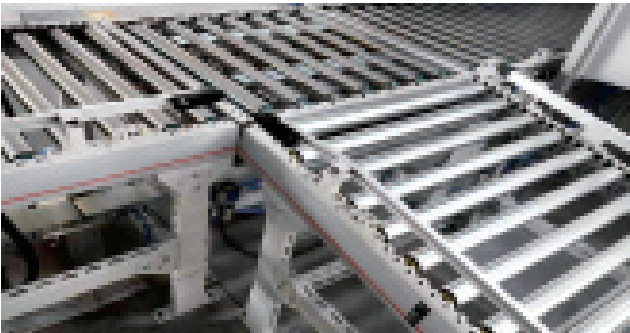

Type: Curve and Straight



Safety guards and hand protection components



Photoelectric sensor components



# APOLLO Pallet Conveyor



Pallet Chain Conveyor



Pallet Roller Conveyor

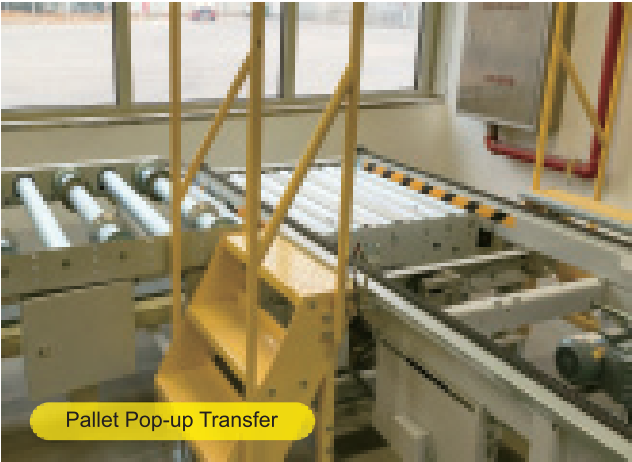

Pallet Pop-up Transfer

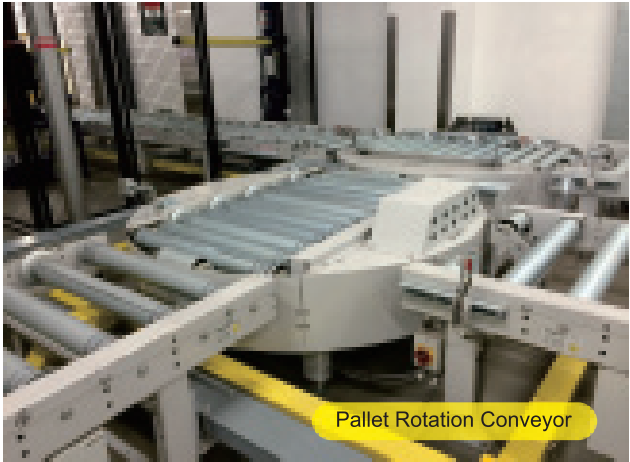

Pallet Rotation Conveyor



Pallet Chain Conveyor

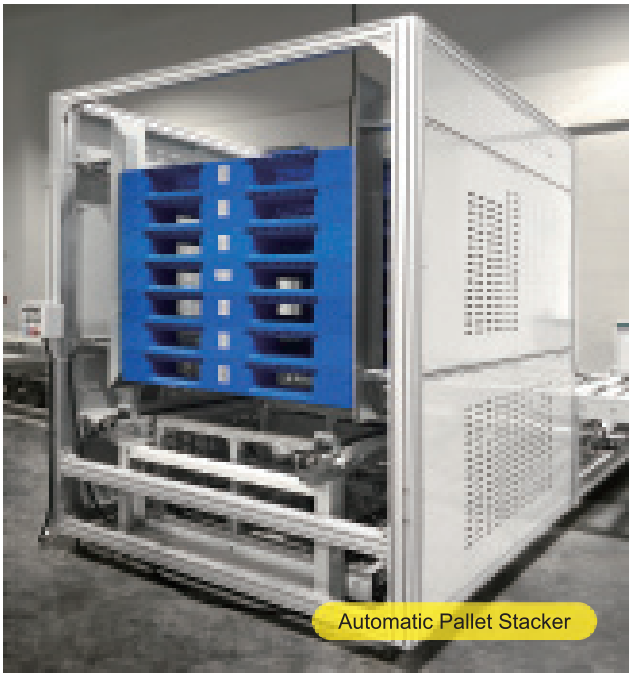

Automatic Pallet Stacker

# Pop-up Transfer



Product introduction:  
See P.39-46 for details



Scan QR code on WeChat to  
watch video

## Selection parameters of APOLLO Pop-up Transfer (three-in-one high-efficiency model)

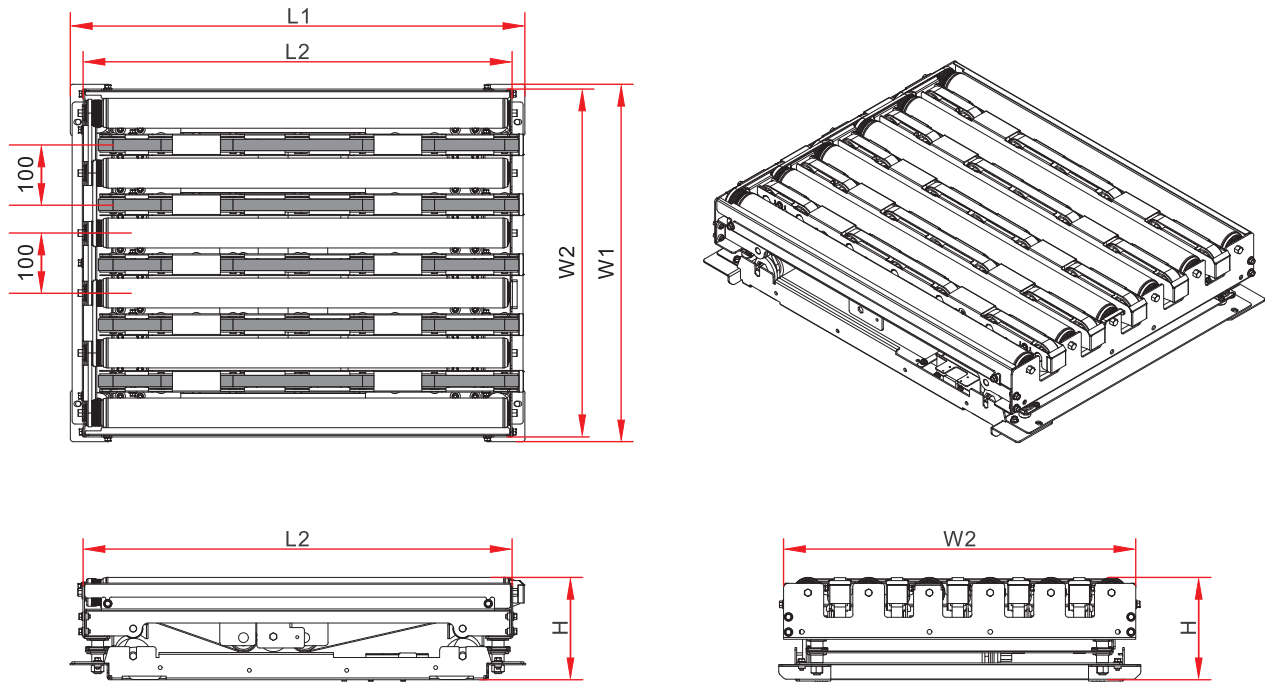

Technical Parameters (three-in-one high-efficiency model)

Specifications	Model	Conveying size (mm)		Dimensions (mm)			Adapt to the width of the conveyor line
		L1	W1	L2	W2	H	
	A400	758	396	715	380	170	400-450 mm
B500	758	496	715	480	170	500-550 mm	
C600	758	596	715	580	170	600-650 mm	
D700	758	696	715	680	170	700-850 mm	
Conveying speed	≤60 m/min						
Cargo size	≥250×250 mm						
Rated load	≤50 kg						
Conveying efficiency	≤1800 products/hour						
Conveying method	Roller Drive (2 pieces)						
Lifting method	Roller Drive (1 piece)						
Communication signal	PNP / NPN						
Equipment material	Galvanized / Stainless Steel						

# Pop-up Transfer



## Application of APOLLO Pop-up Transfer (three-in-one high-efficiency model)

Application scenario 1

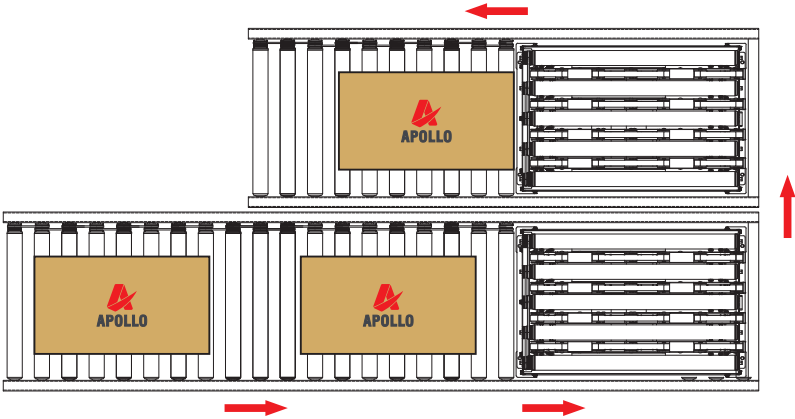

Application scenario 2

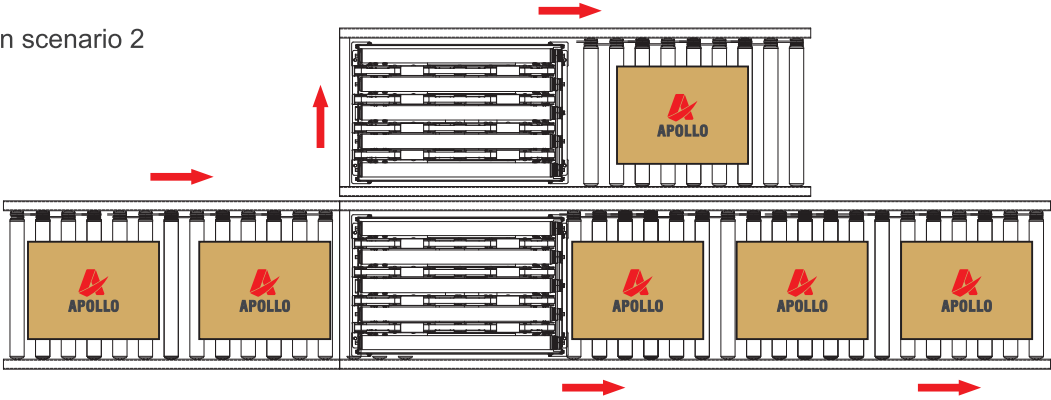

Application scenario 3

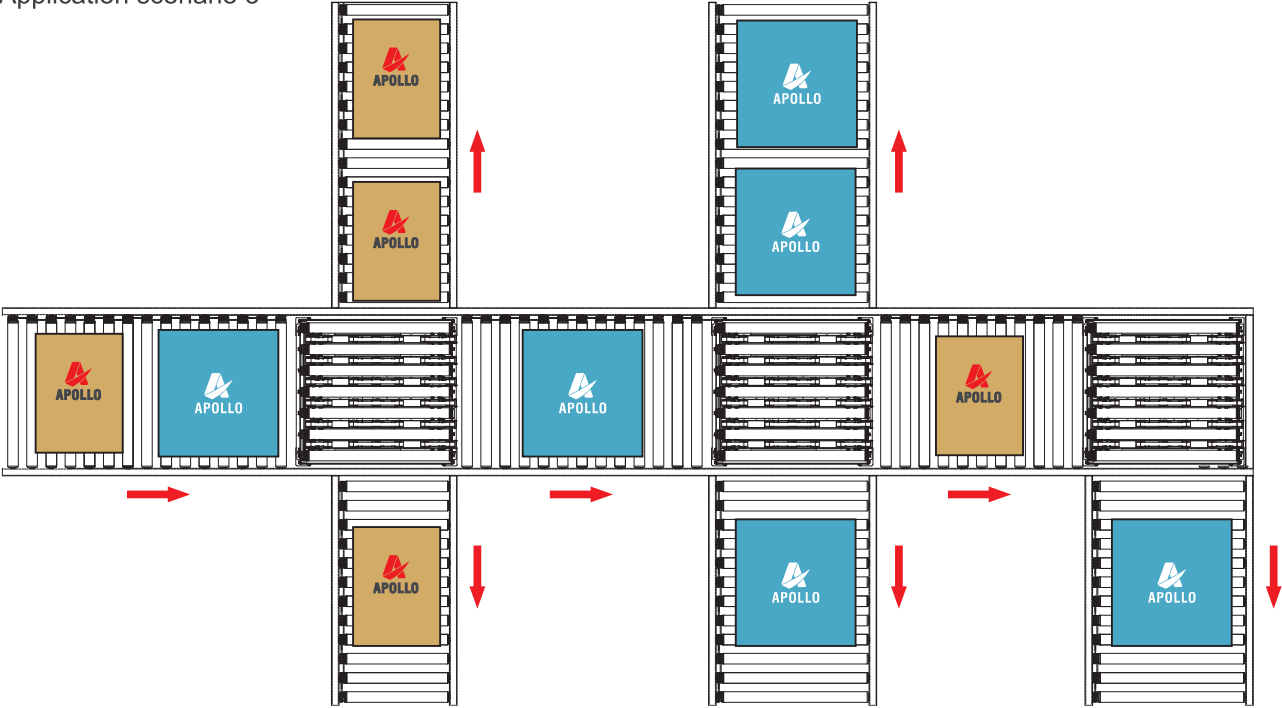

## Application of APOLLO Pop-up Transfer (three-in-one high-efficiency model)



### Features:

Wide adaptability, easy installation, strong controllability, high safety, maintenance-free and low failure rate.

APOLLO Pop-up Transfer is a transfer machine with extremely high cost performance.

APOLLO Pop-up Transfer can realize gentle transportation of goods and applied to various sorting and transferring fields. Through modular and standardized design, it can be perfectly combined with the conveyor lines for most customers' sites.

APOLLO Pop-up Transfer is designed to provide a low-impact, high-performance, non-damaging steering transportation for goods. It has high fatigue resistance and long service life, making it to be the best right-angle steering equipment for small and medium-sized sorting sites.



# Pop-up Transfer



## Application of APOLLO Pop-up Transfer (three-in-one high-efficiency model)



# Pop-up Transfer



## Application of APOLLO Stainless Steel Pop-up Transfer (three-in-one high-efficiency model)



## Selection parameters of APOLLO Pop-up Transfer (two-in-one simple model)

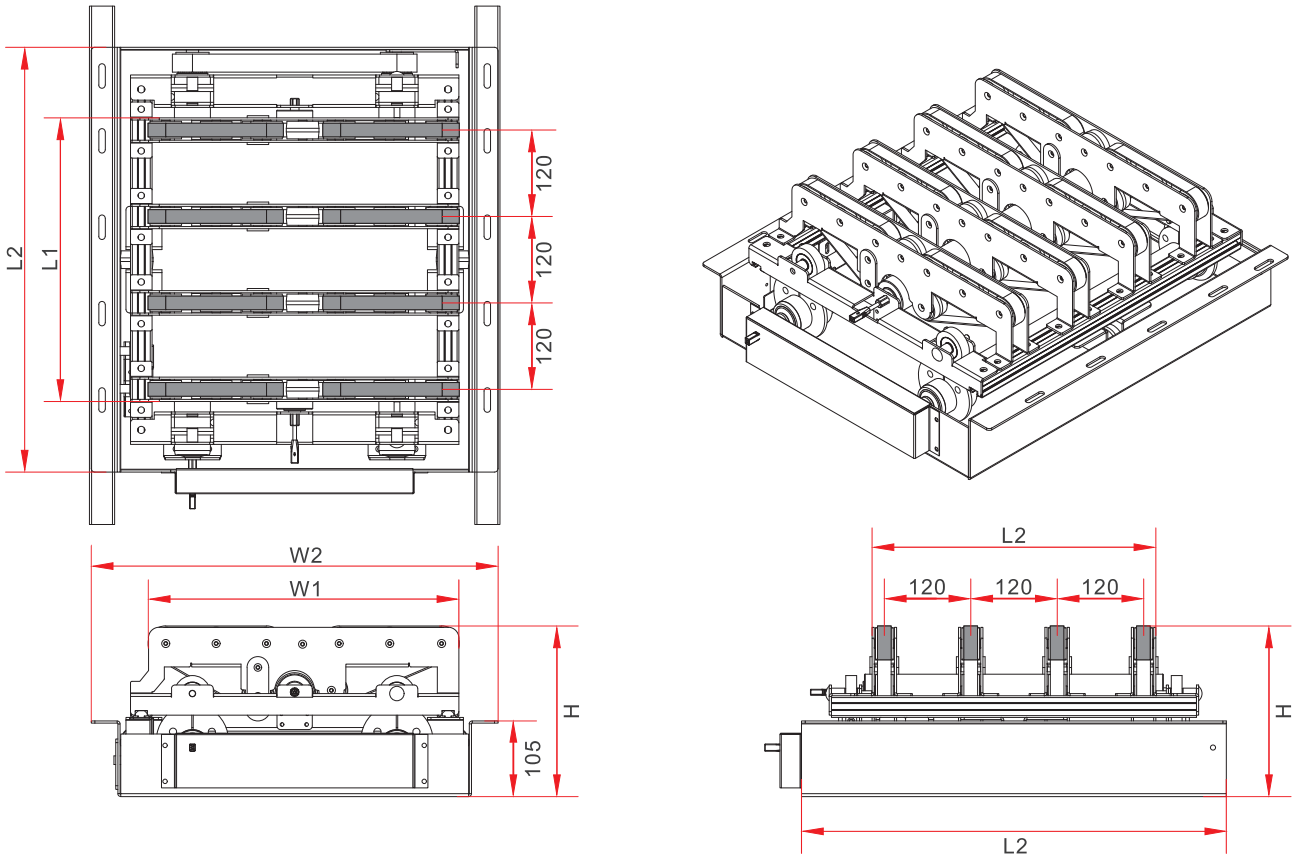

Technical Parameters (two-in-one simple model)

Specifications	Model	Conveying size (mm)		Dimensions (mm)			Adapt to the width of the conveyor line
		L1	W1	L2	W2	H	
	S500	394	431	590	565	237	500 mm
	S600	394	531	590	665	237	600 mm
	S700	394	631	590	765	237	700 mm
	S800	394	731	590	865	237	800 mm
Conveying speed	≤60 m/min						
Cargo size	≥300×300 mm						
Rated load	≤50 kg						
Conveying efficiency	≤1200 products/hour						
Conveying method	Roller Drive (2 pieces)						
Lifting method	Roller Drive (1 piece)						
Communication signal	PNP / NPN						
Equipment material	Galvanized / Stainless Steel						

Application of APOLLO Pop-up Transfer  
(two-in-one simple model)

---

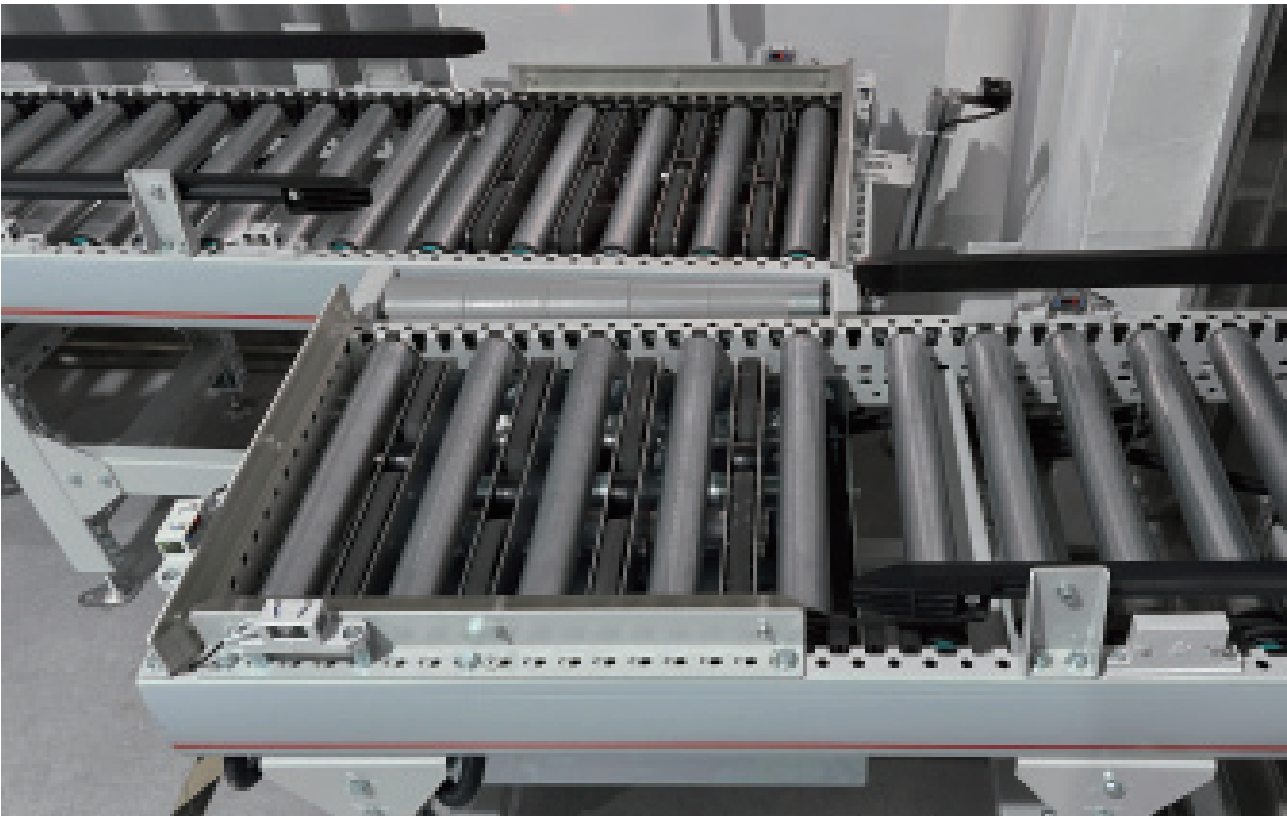

# Pop-up Diverter

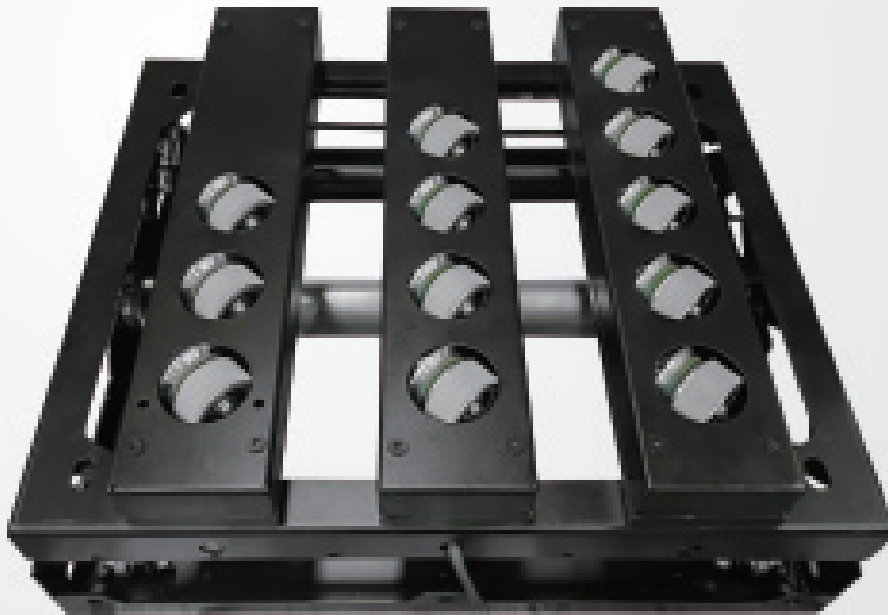

Product introduction:  
See P.47-49 for details



Scan QR code on WeChat to  
watch video

## Selection parameters of APOLLO Pop-up Diverter

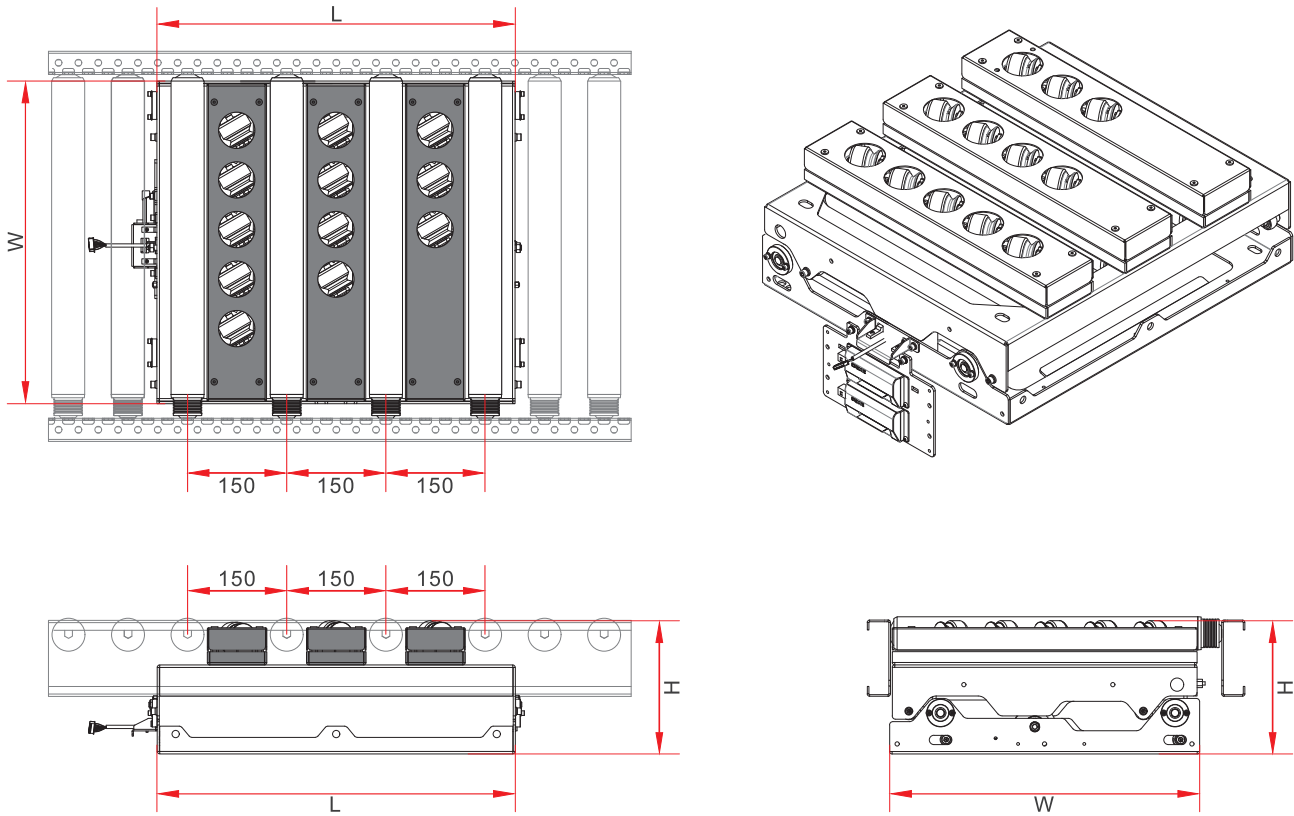

Technical Parameters					
Specifications	Model	Dimensions (mm)			Adapt to the width of the conveyor line
		L	W	H	
	DF400	392	388	200	400 mm
	DF500	542	488	200	500 mm
	DF600	542	588	200	600 mm
DF700	692	688	200	700 mm	
Steering angle	30° / 45°				
Conveying power	RollerDrive (DC24V50W, simple and convenient electric control)				
Lifting power	RollerDrive (DC24V50W, simple and convenient electric control)				
Operation speed	≤90m / min				
Sorting efficiency	≤2400 products/hour (depend on product sizes)				
Load capacity	≤50kg/product				
Installation	Insert type / equip with support legs				
Equipment color	Black (other colors can be customized)				

# Pop-up Diverter



## Application of APOLLO Pop-up Diverter

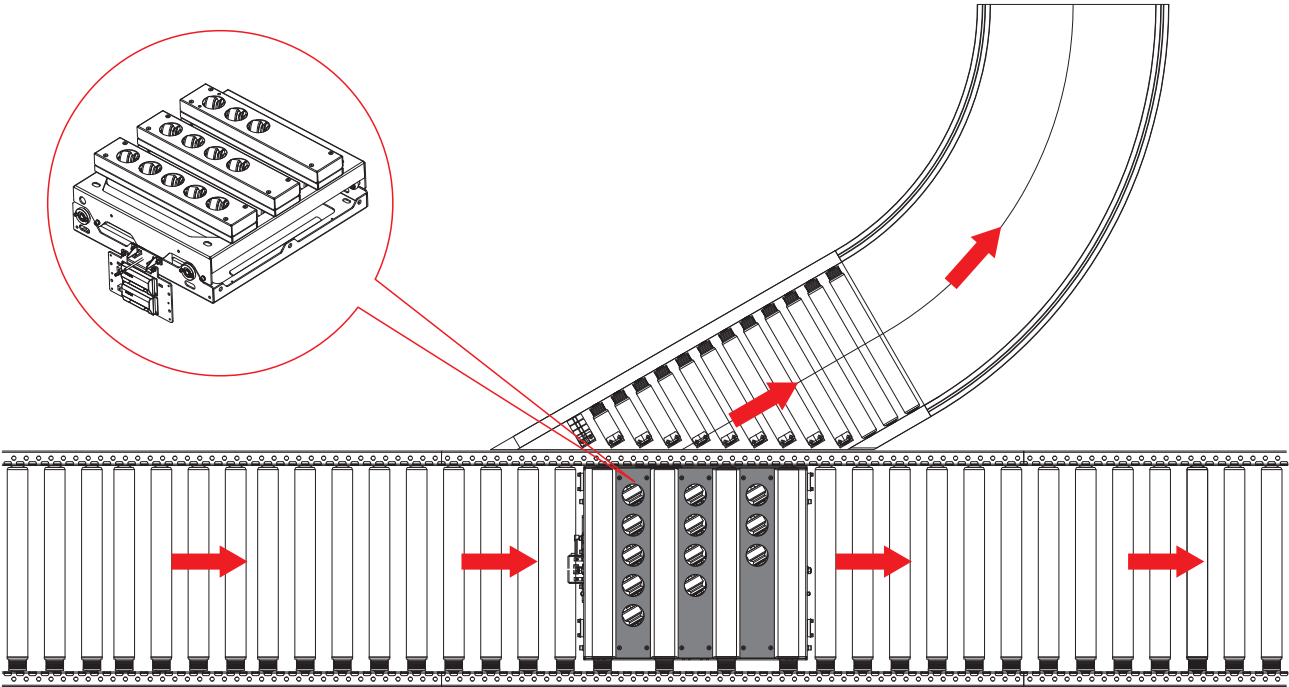

# Picking Station

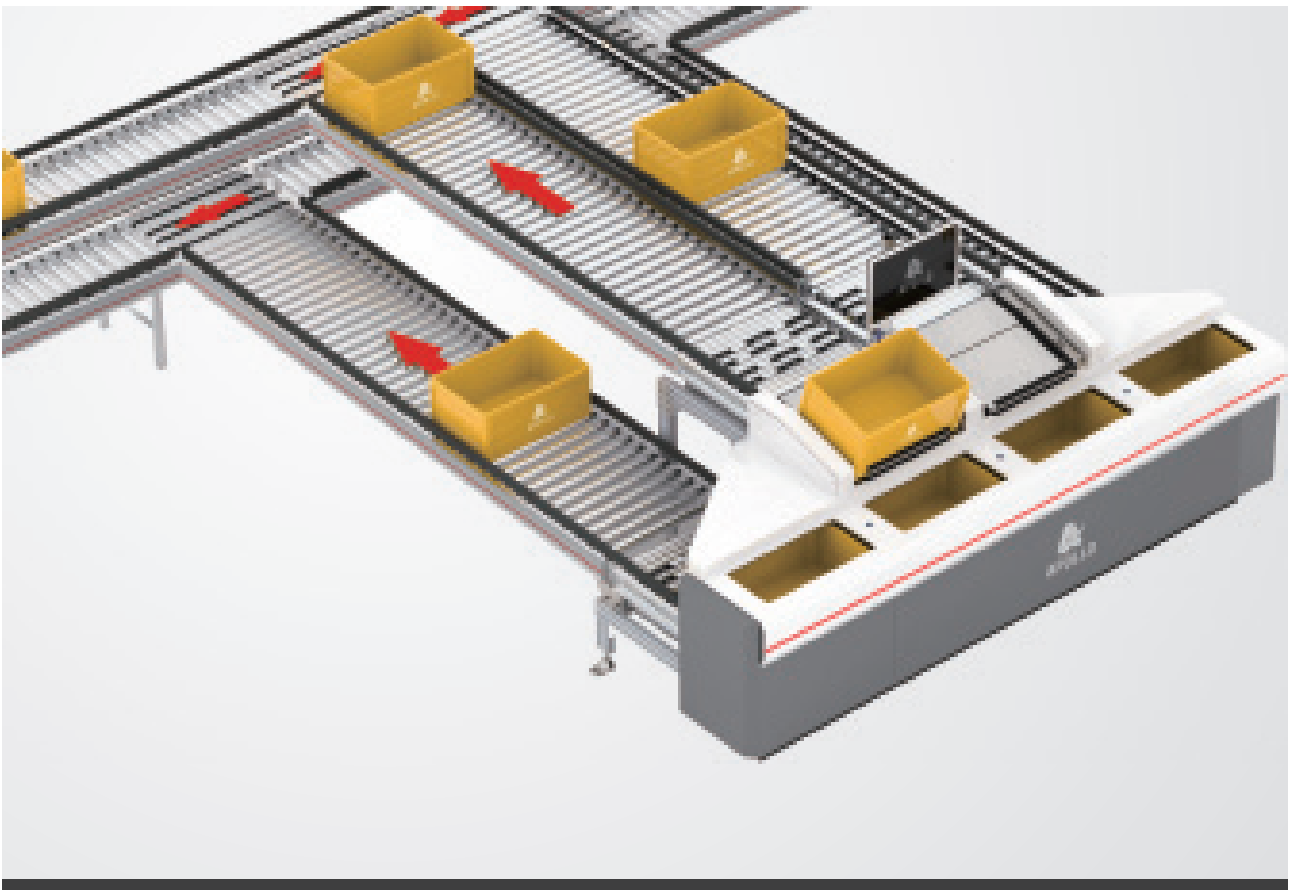

Product introduction:  
See P.50-52 for details



Scan QR code on WeChat to  
watch video

# Picking Station



## Selection parameters of APOLLO Goods-to-Person Picking Station

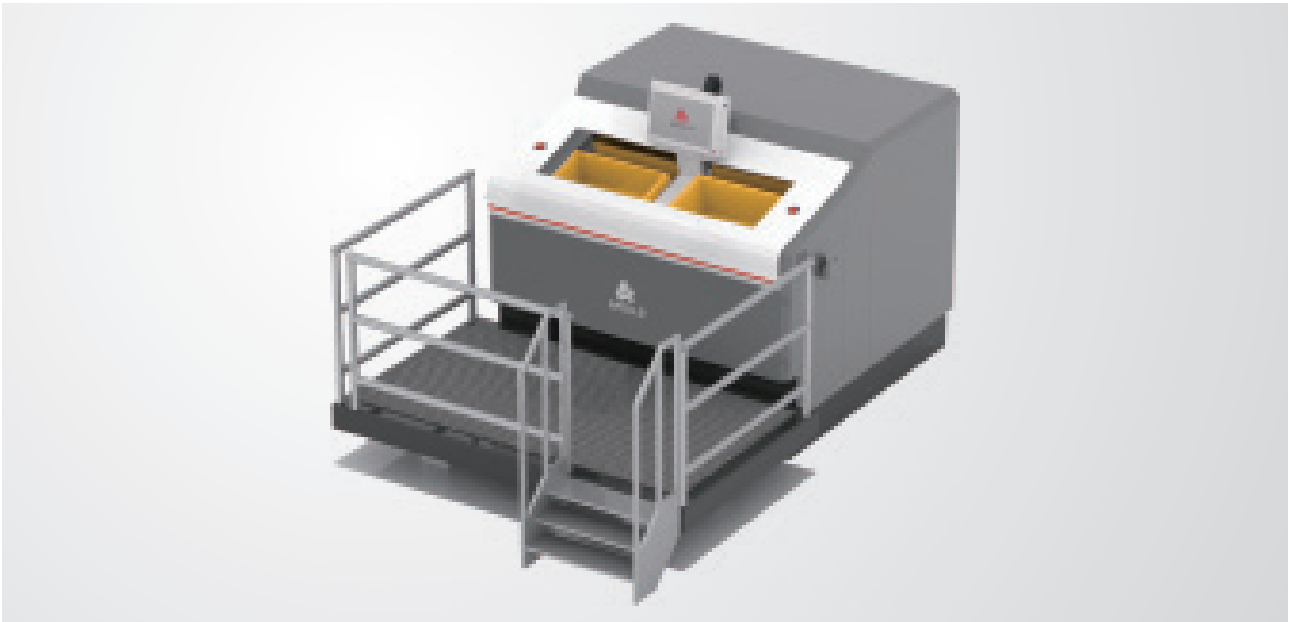

Technical Parameters	
Parameter name	Goods-to-Person Picking Station
Picking station	1 person 2 workstations, 2 people 4 workstations
Picking efficiency	≤600 boxes/hour
Selection guide	LED light reminder
Application range	Picking by connecting to the conveyor system, picking by miniload outbound goods
Equipment material	Carbon steel and powder coated

## Application of APOLLO Goods-to-Person Picking Station

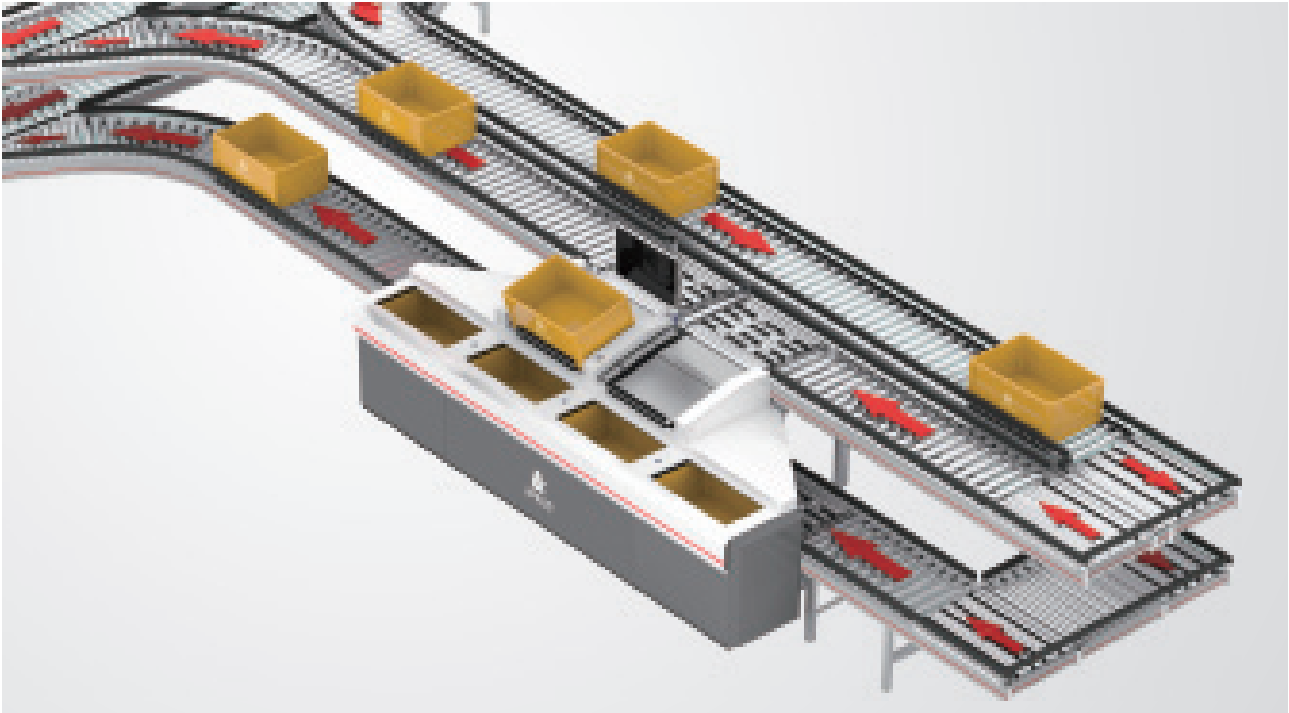

APOLLO Goods-to-Person Picking Station, simple, flexible and faster! We offer you innovative, ergonomic and flexible order picking solutions.

APOLLO Goods-to-Person Picking Station can be connected to various conveyor systems to improve picking efficiency and reduce repetitive pressure on employees.

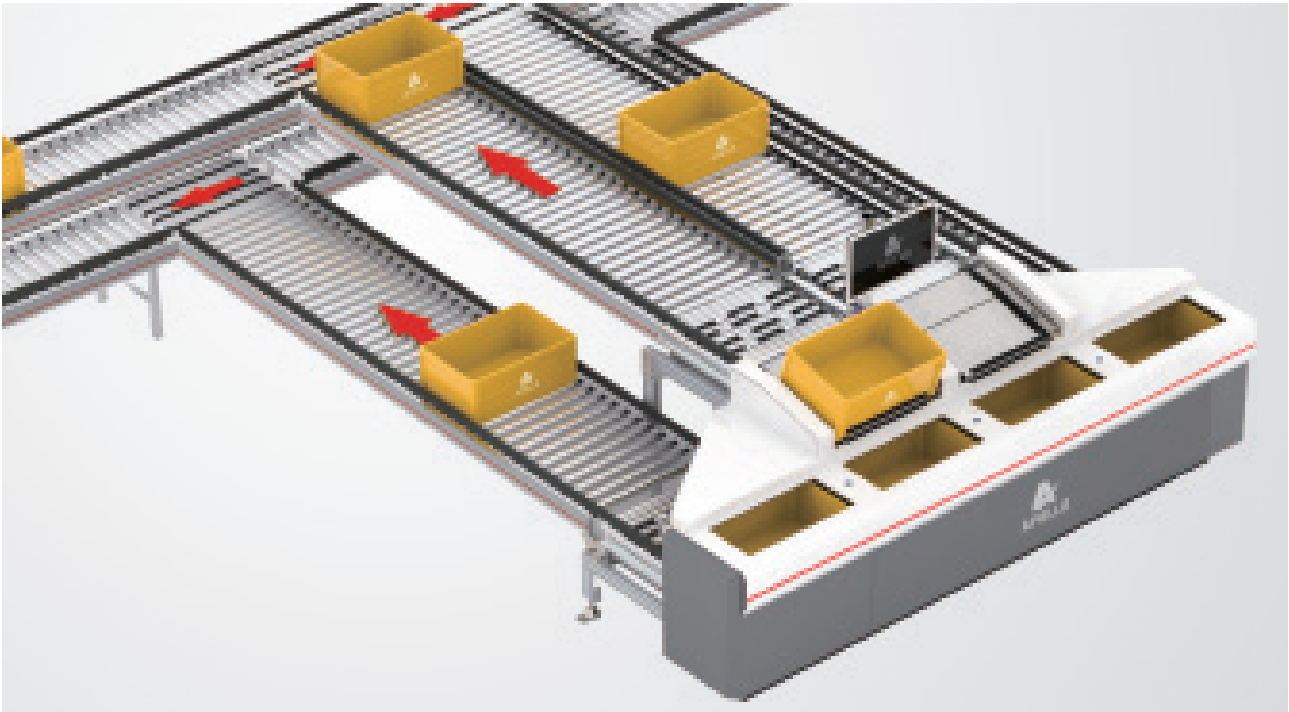

## Automatic Box Destacking / Stacking machine

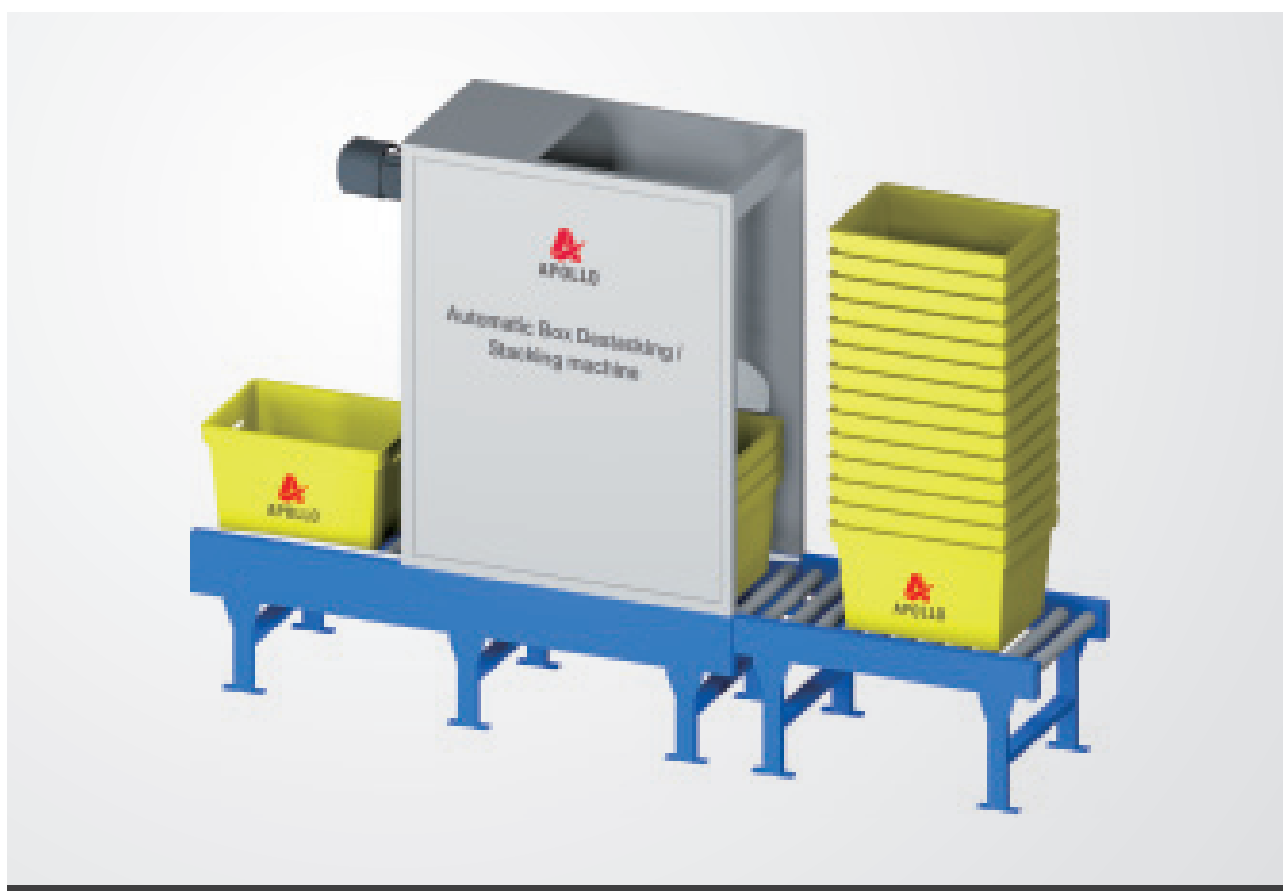

Product introduction:  
See P.53-54 for details



Scan QR code on WeChat to  
watch video

## Selection parameters of APOLLO Automatic Box Destacking / Stacking machine

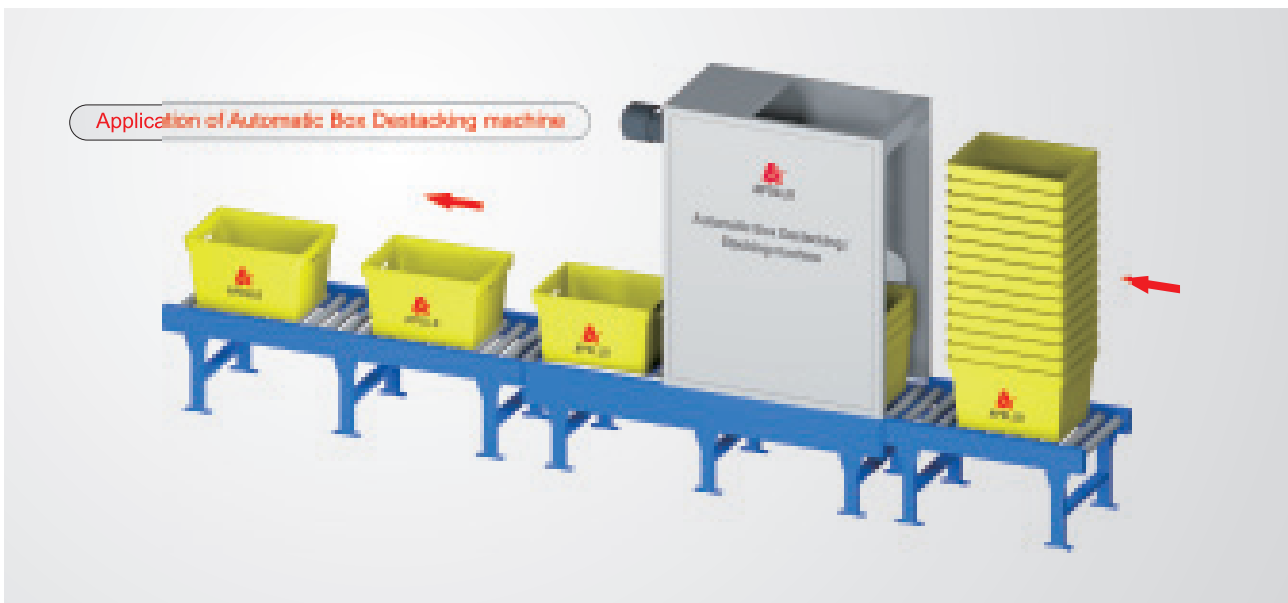
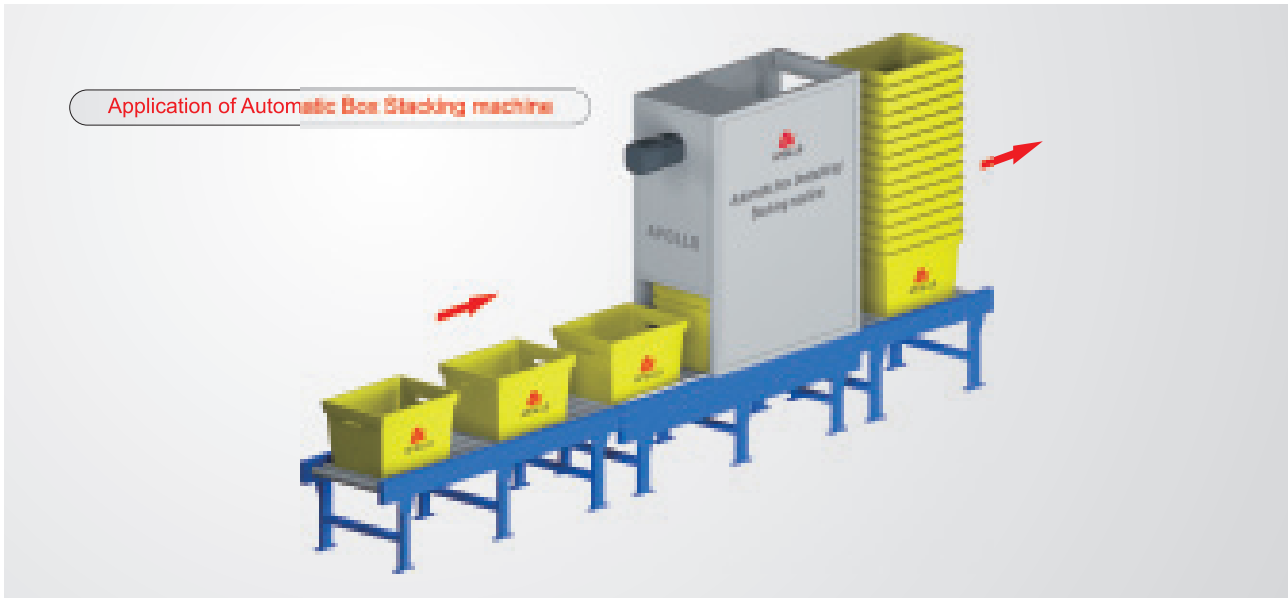

### Technical Parameters

Parameter name	Automatic Box Destacking / Stacking machine
Number of layers to be destacked / stacked	2-20 boxes/stack
Destacking / Stacking efficiency	500-800 products/hour
Action mechanism	Full servo mechanism (no air source required)
Conveying products	Standard turnover box / plastic basket
Dimensions	L1800xW600x H1800mm (suitable for 600x400x 300mm boxes)
Equipment material	Carbon steel / stainless steel

# Telescopic Belt Conveyor



Product introduction:  
See P.55-61 for details



Scan QR code on WeChat to  
watch video

## Telescopic Belt Conveyor (Fixed Type)



### Selection parameters of APOLLO Fixed Telescopic Belt Conveyor

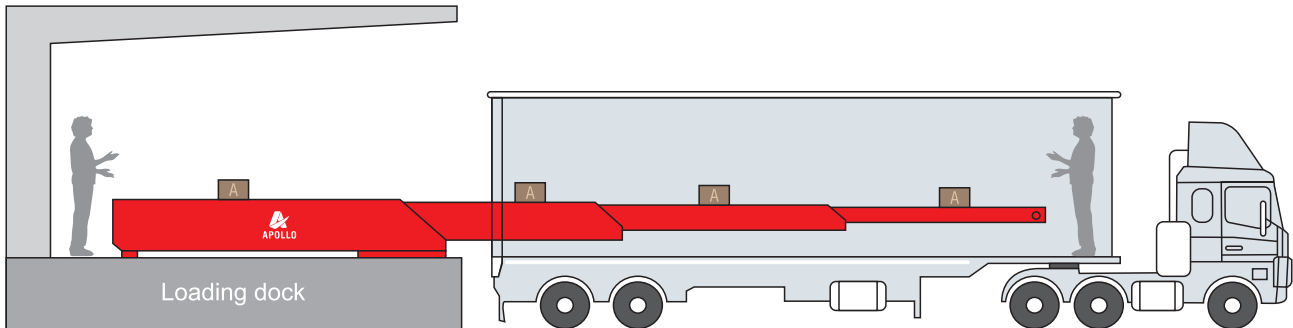

● Suitable to use on loading dock



### Fixed Telescopic Belt Conveyor Parameters

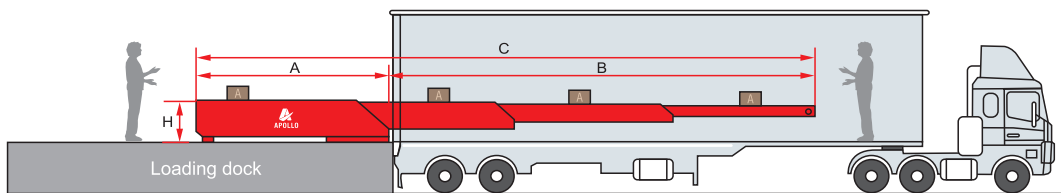

Model	Sections	Total length C (mm)	Fixed length A (mm)	Extension length B (mm)	Height (mm)	Belt width (mm)	Optional functions
A3-6+8	3 sections	14000	6000	8000	800	600/800/1000/1200	<ul style="list-style-type: none"> <li>● Hydraulic lifting</li> <li>● Standing platform</li> <li>● Drop snoot</li> <li>● Swing arm</li> <li>● Counter</li> <li>● Anti-dropping</li> <li>● Wireless remote</li> <li>● On-line control</li> <li>● Air-conditioning device</li> </ul>
A3-7+9.5		16500	7000	9500	800	600/800/1000/1200	
A4-5+10	4 sections	15000	5000	10000	900	600/800/1000/1200	
A4-6+12		18000	6000	12000	900	600/800/1000/1200	
A4-7+14		21000	7000	14000	900	600/800/1000/1200	
A4-8+16		24000	8000	16000	900	600/800/1000/1200	
A5-6+15	5 sections	21000	6000	15000	1150	600/800/1000/1200	
A5-7+16		23000	7000	16000	1150	600/800/1000/1200	
A6-4.5+13	6 sections	17500	4500	13000	1200	600/800/1000	
A6-5+16		21000	5000	16000	1200	600/800/1000	

Remark: The above are APOLLO standard models, if you need other sizes, please contact our sales freely.

Telescopic Belt Conveyor  
(Fixed Type)



APOLLO Fixed Type Telescopic Belt Conveyor Application

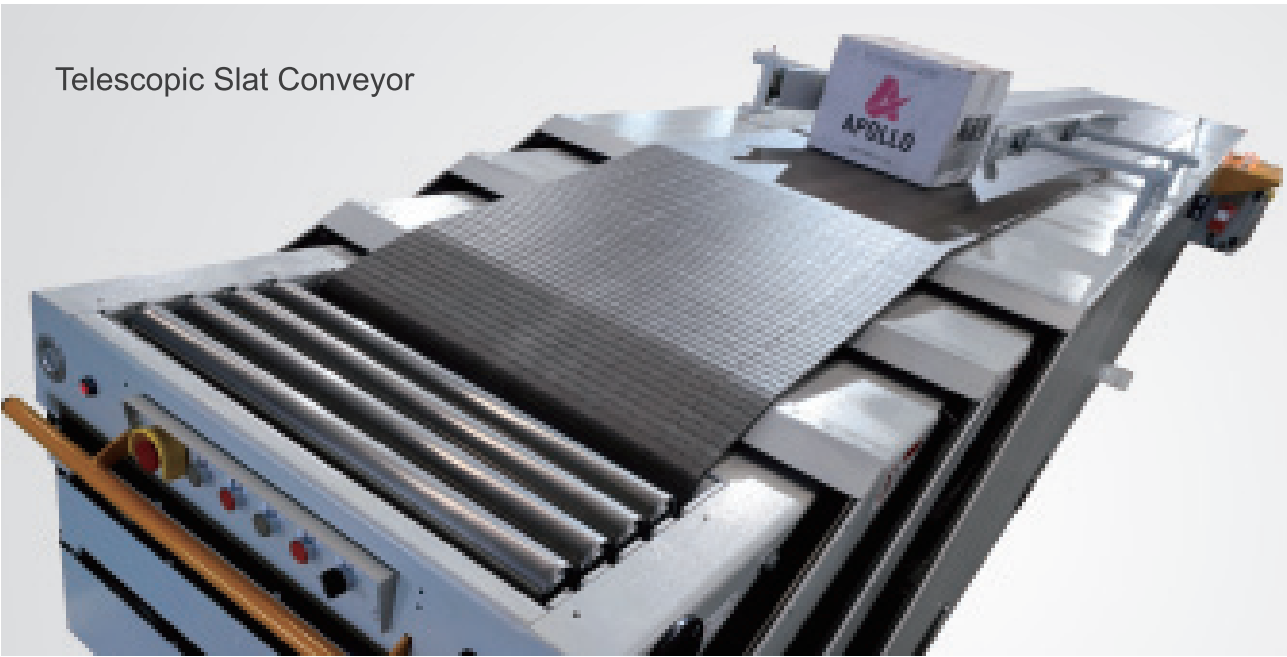
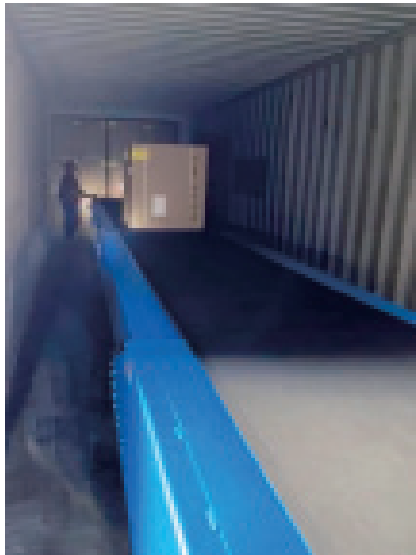
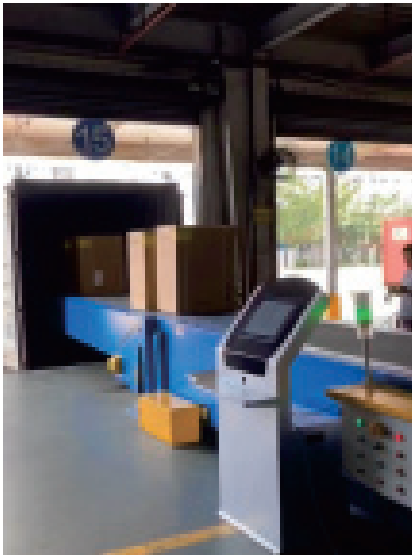

Telescopic Belt Conveyor  
(Movable Type)



## APOLLO Movable Type Telescopic Belt Conveyor Selection

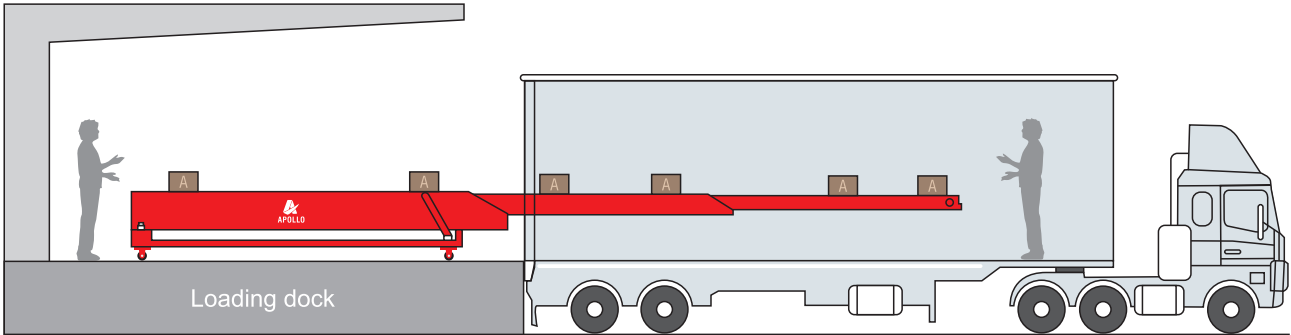

● Suitable to use on loading dock

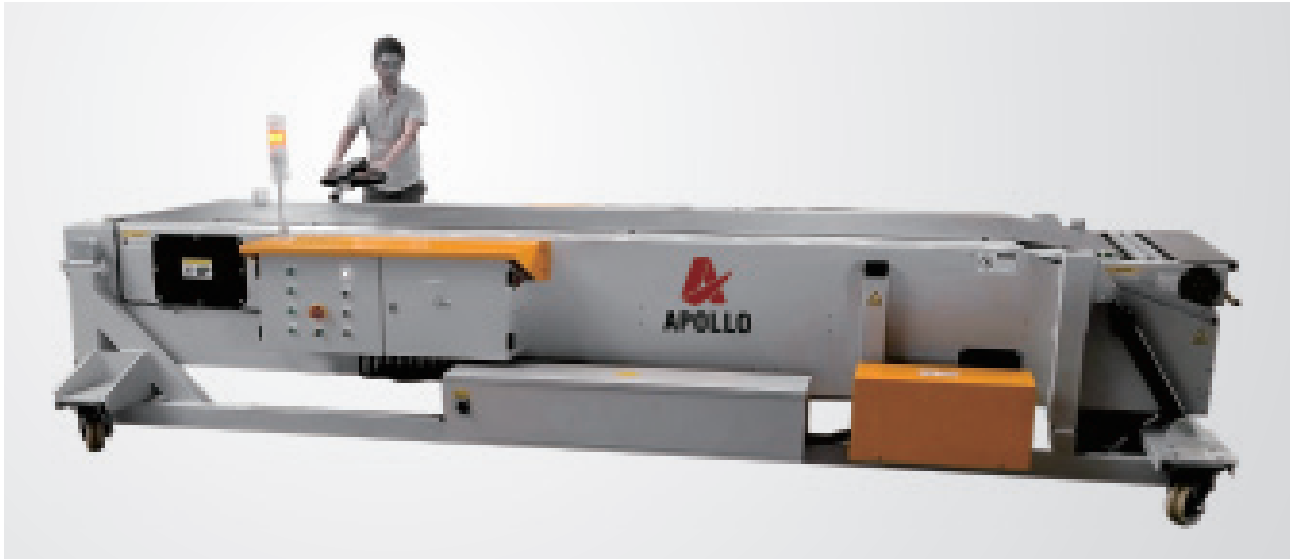

## Movable Telescopic Belt Conveyor Parameters

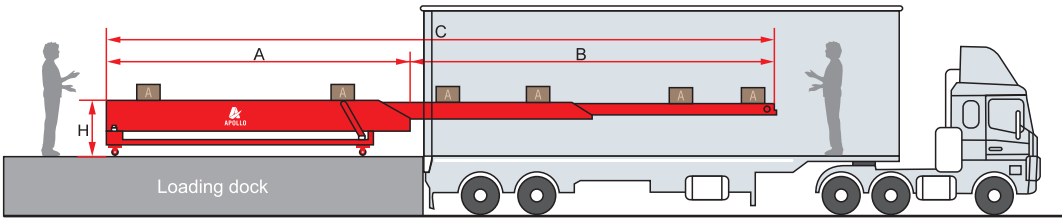

Model	Sections	Total length C (mm)	Fixed length A (mm)	Extension length B (mm)	Height (mm)	Belt width (mm)	Mobile way
M3-6+8	3 sections	14000	6000	8000	900	600/800/1000/1200	Manual / Motorized
M3-7+9.5		16500	7000	9500	900	600/800/1000/1200	Manual / Motorized
M4-5+10	4 sections	15000	5000	10000	1100	600/800/1000/1200	Motorized
M4-6+12		18000	6000	12000	1100	600/800/1000/1200	Motorized
M4-7+14		21000	7000	14000	1100	600/800/1000/1200	Motorized / Rail
M4-8+16		24000	8000	16000	1100	600/800/1000/1200	Motorized / Rail

Remark: The above are APOLLO standard models, if you need other sizes, please contact our sales freely.

APOLLO Movable Type Telescopic Belt Conveyor Types and Application

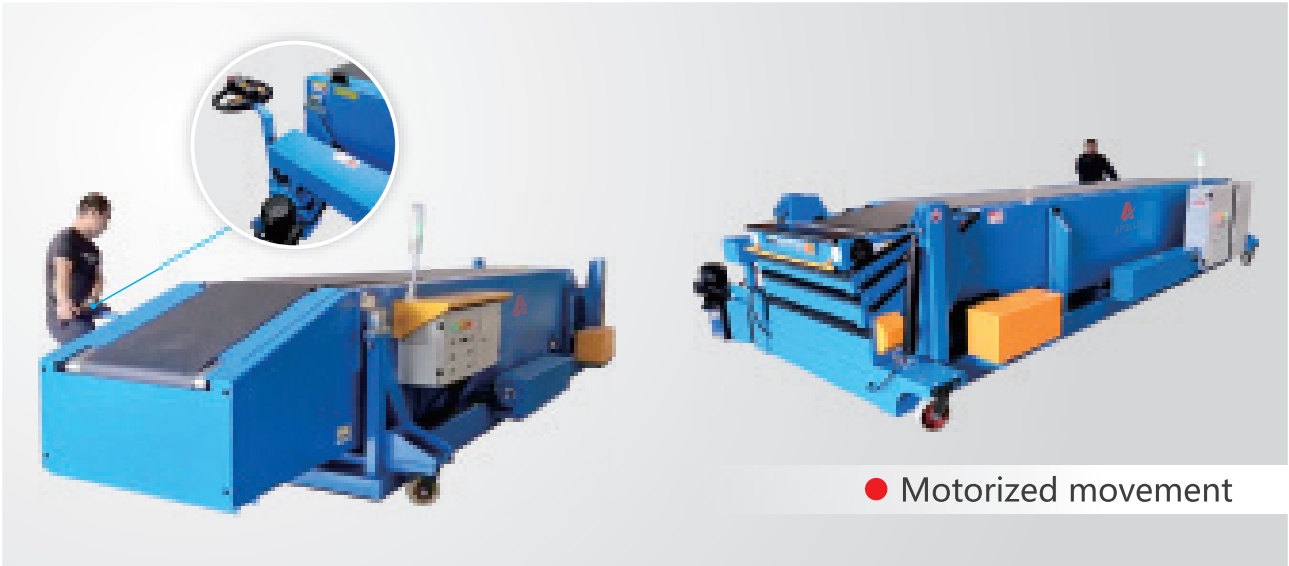

Telescopic Belt Conveyor  
(High Chassis Type)



## APOLLO High Chassis Type Telescopic Belt Conveyor Selection (without loading dock)

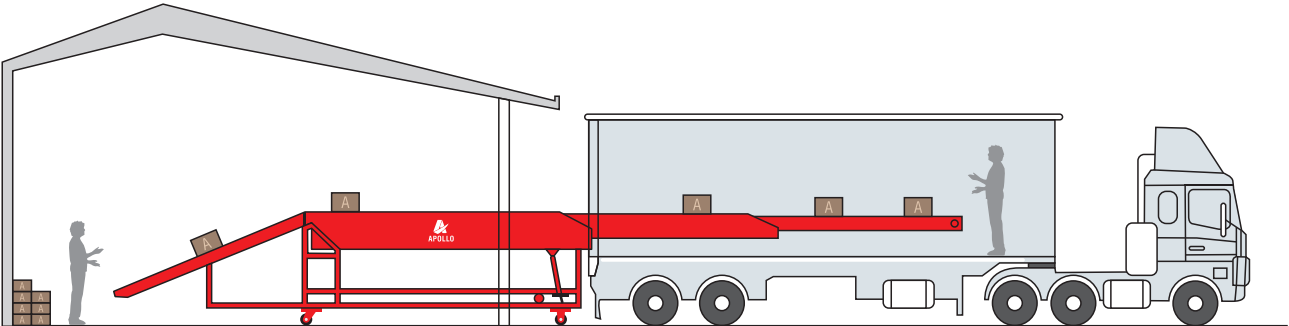

● Suitable to use without loading dock



## APOLLO High Chassis Type Telescopic Belt Conveyor Parameters

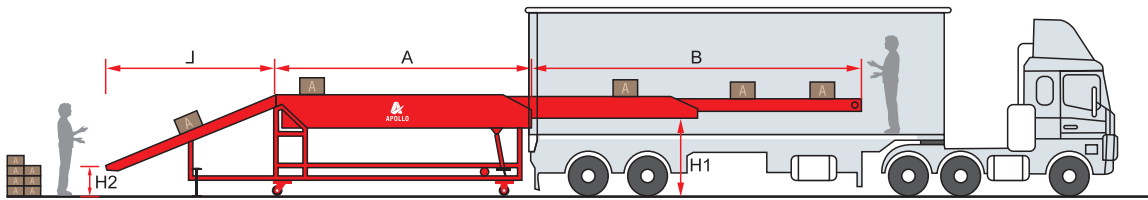

Model	Sections	Fixed length A (mm)	Extension length B (mm)	Slope L (mm)	Height H1 / H2 (mm)	Belt width (mm)	Installation way
V3-5+6.5	3 sections	5000	6500	4000	1600/750	600/800/1000/1200	Fixed / Mobile
V3-6+8		6000	8000	4000	1600/750	600/800/1000/1200	Fixed / Mobile
V4-5+10	4 sections	5000	10000	4000/4500	1600/750	600/800/1000/1200	Fixed / Mobile
V4-6+12		6000	12000	4000/4500	1600/750	600/800/1000/1200	Fixed / Mobile
V4-7+14		7000	14000	4000/4500	1600/750	600/800/1000/1200	Fixed / Mobile

Remark: The above are APOLLO standard models, if you need other sizes, please contact our sales freely.

Telescopic Belt Conveyor  
(High Chassis Type)



APOLLO High Chassis Type  
Telescopic Belt Conveyor Application (without loading dock)



● Movable High Chassis Type



● Fixed High Chassis Type



● Rail Movement High Chassis Type

# Flexible Roller Conveyor



Product introduction:  
See P.62-64 for details



Scan QR code on WeChat to  
watch video

## APOLLO Flexible Roller Conveyor Selection

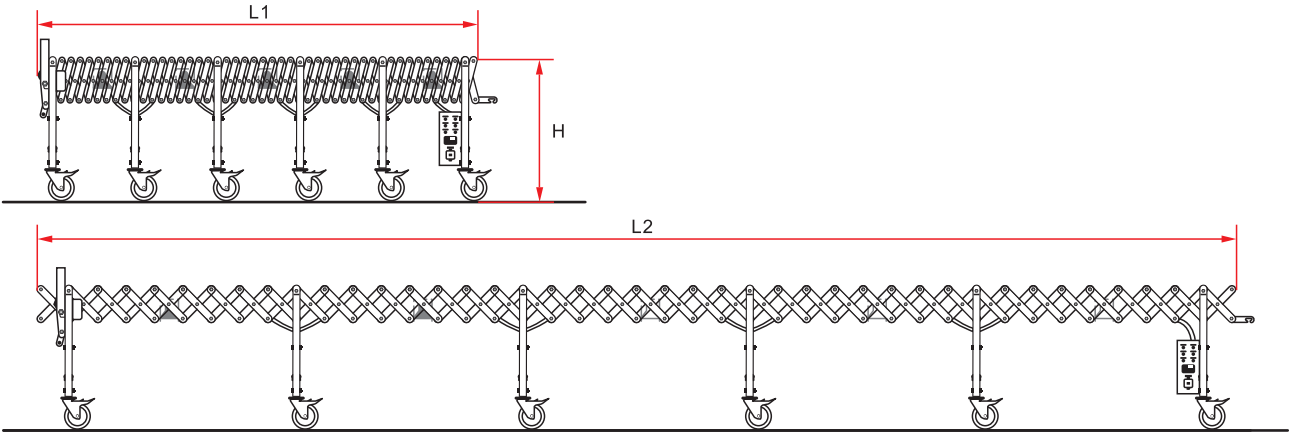

Model	Extended length L2 (mm)	Retracted length L1 (mm)	Height H (mm)	Roller width (mm)	Frame width (mm)	Roller material	Side guards
R-4500	4000	1550	700-1000	600/800	670/870	Galvanized / Stainless Steel	Optional
R-6500	6000	2300	700-1000	600/800	670/870	Galvanized / Stainless Steel	Optional
R-8000	8000	3100	700-1000	600/800	670/870	Galvanized / Stainless Steel	Optional
R-10000	10000	3850	700-1000	600/800	670/870	Galvanized / Stainless Steel	Optional
R-12000	12000	4700	700-1000	600/800	670/870	Galvanized / Stainless Steel	Optional
R-15000	15000	5800	700-1000	600/800	670/870	Galvanized / Stainless Steel	Optional

Remark: The above is APOLLO standard models, if you need other sizes, please contact our sales freely.

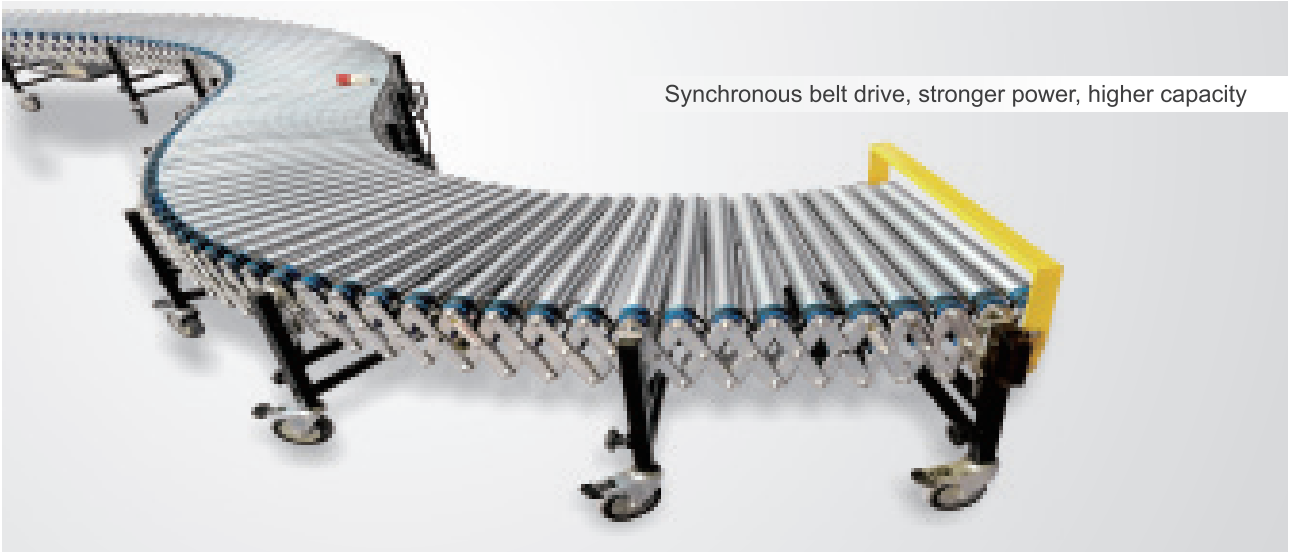

APOLLO can provide customers with better factory logistics planning solutions through international experience in factory logistics innovation and optimization,

APOLLO Flexible Roller Conveyor is suitable for flexible and changeable occasion. Driven by motor, goods is transmitted automatically along with roller, no need manual to push goods; Shorten the distance of manual handling materials back and forth, shorten time, reduce the labor intensity, reduce the goods damage and improve the work efficiency.

APOLLO Flexible Roller Conveyor can be used alone, also can be combined with other conveying equipment, often used in goods transfer in the logistics center, enterprise storage, food, beverage etc. Directly used on ground after stretching, normally use to convey cartons with capacity 60 kg/m.

## APOLLO Flexible Roller Conveyor Application



# Mobile Loading Conveyor



Product introduction:  
See P.65-66 for details



Scan QR code on WeChat to  
watch video

## APOLLO Mobile Loading Conveyor Selection

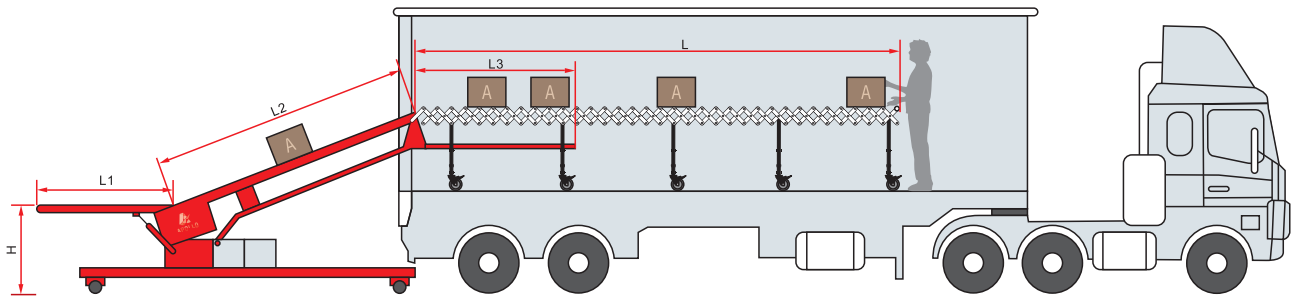

Technical Parameters						
Model	L1 (mm)	L2 (mm)	L3 (mm)	L (mm)	H (mm)	Belt width (mm)
B6-600	1200	3500	2600	6000	500-750	600
B6-800	1200	3500	2600	6000	500-750	800

Remark: The above is APOLLO standard models, if you need other sizes, please contact our sales freely.



# Sliding Shoe Sorter

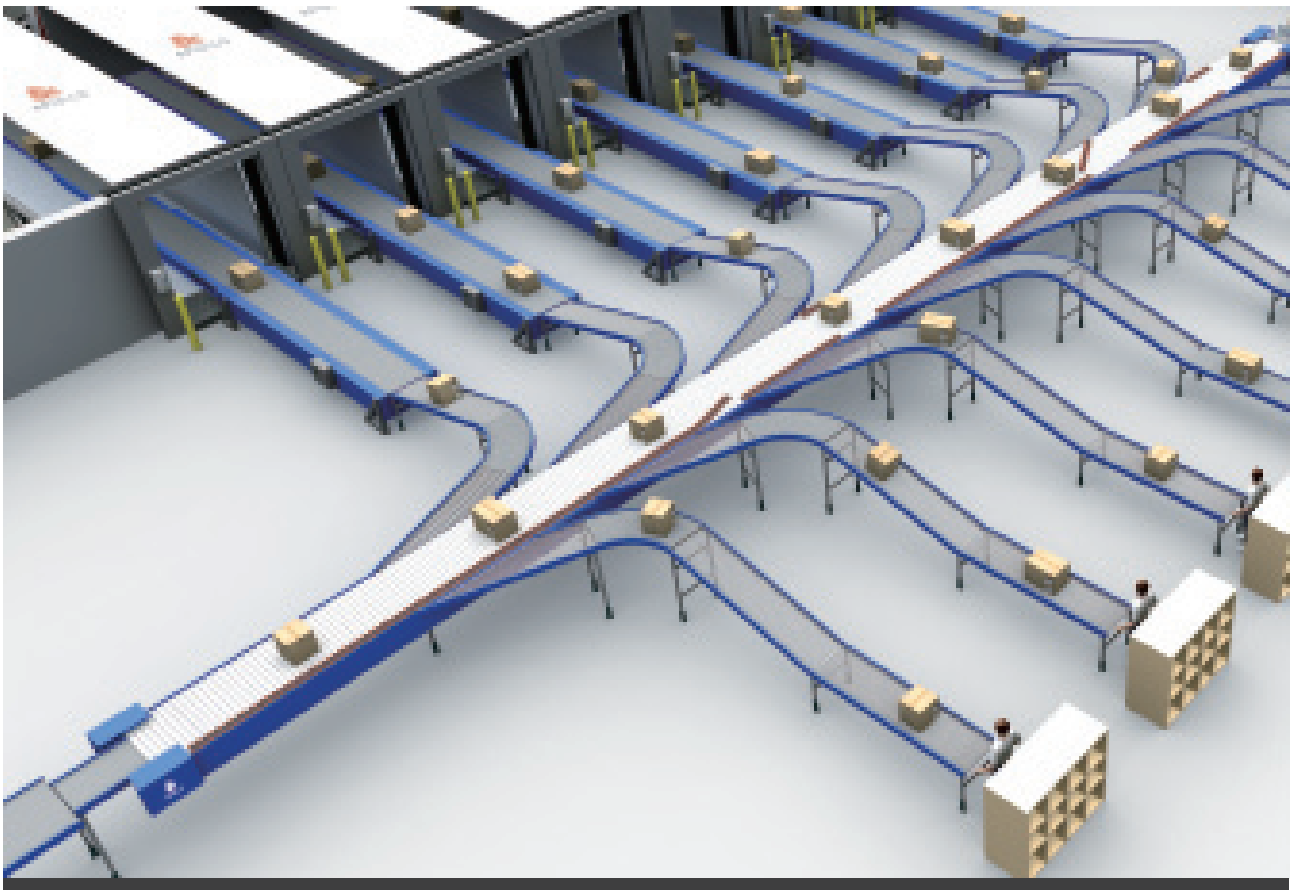

Product introduction:  
See P.67-74 for details



Scan QR code on WeChat to  
watch video

## APOLLO Sliding Shoe Sorter Application



### Applications

- E-commerce, Logistic center, Pharmaceuticals, Clothes, Food, Tires, Furniture etc.

### Applicable Products

- Cartons, turnover boxes, tires, packages, etc.

### Sorting range

Products can be sorted	length (mm)	Width (mm)	Height (mm)	Weight (kg)
Min.	100	50	5	0.25
Max.	1800	1000	1000	60

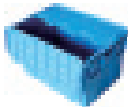

## APOLLO Sliding Shoe Sorter Selection

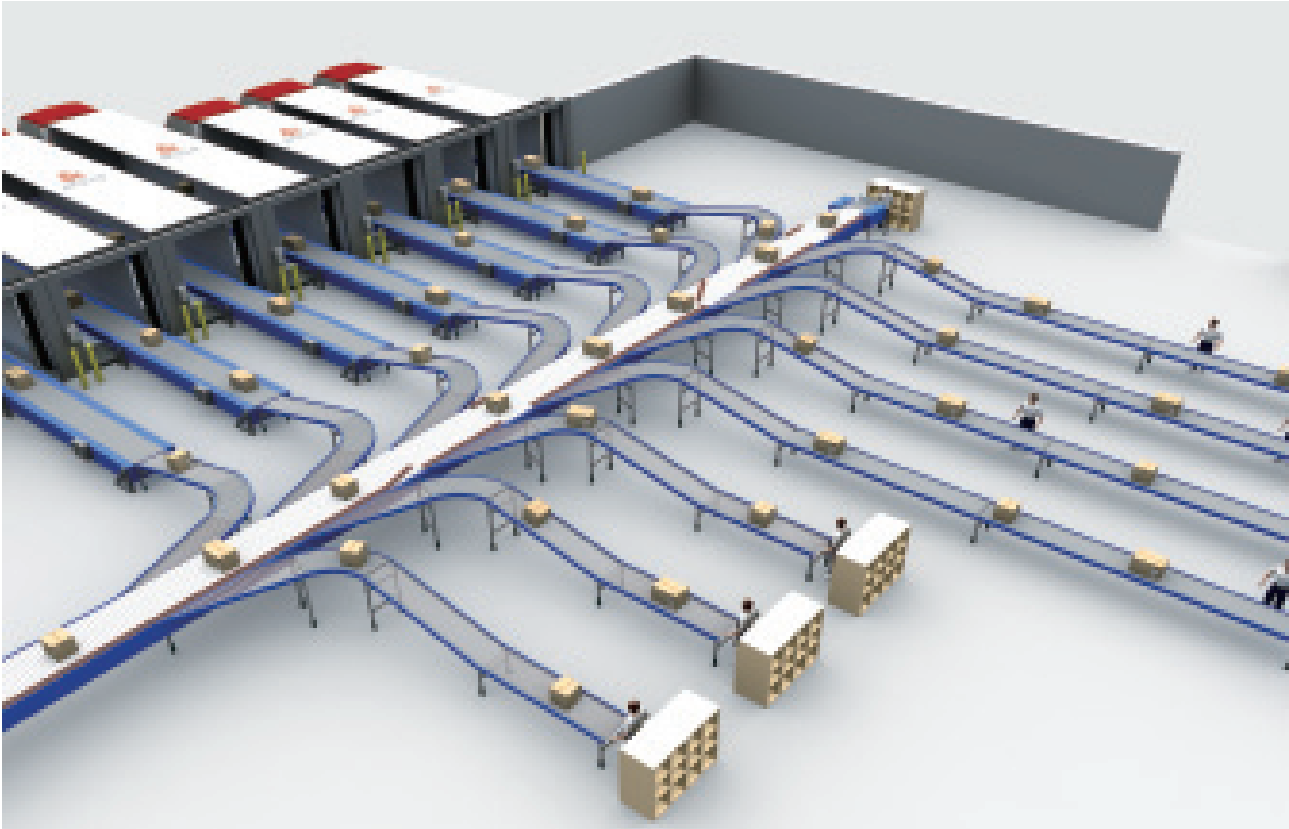

Technical Parameters

Parameter name	Specification	Remark
Equipment Type	Single side / Double side	/
Equipment Length	10m - 150m	Depend on proposal
Equipment Width	500mm / 600mm / 800mm / 1000mm	Can customize width
Equipment Height	1000mm - 4000mm	Can customize height
Equipment Material	Aluminum alloy	Accessories are carbon steel

Products can be sorted	Cartons, Turnover boxes, Tires, Parcels etc.	/
Goods weight	0.1-60 kg/package	/
Sorting efficiency	3000-5000 PPH/ 5000-8000 PPH/ 8000-10000 PPH	Dependon specifications of the goods
Run speed	Standard: 1.5 m/s - 2.5 m/s	Maximum customize to 3m/s

Working voltage	3 phase 380V、415V、480V	Voltage can be customized
System software & DWS	APOLLO control software	Can customize as requirements

## APOLLO Sliding Shoe Sorter Features

- Solve the optimization of enterprise internal logistics requirements, making the logistics sorting link more faster, flexible and effective
- Improve user's sorting efficiency, reduce enterprise logistics cost

### Features

- High efficiency sorting
- Low sorting error rate
- Basically realize unmanned sorting
- Small occupation, save space
- Gentle handle, small impact, reduce damage on goods
- No limit on product shape, products type to be sorted are extensive
- Able to sort goods continuously and in large quantities

### Design Philosophy

- Modular design (easy assembly, easy maintenance, strong versatility)
- High sorting capacity design (high speed and efficient sorting, up to 180m / minute running speed)
- Reliability design (with mature technology and reasonable optimization of internal structure)
- Advanced design (adopt bus control, software developed by APOLLO)
- Variability design ( main conveyor length up to 150m, flexible to adjust or upgrade latest sorting demand)
- Low noise design (with noise absorption mechanism and sound-proof materials)
- Closed design (safety, aesthetic, noise reduction, protection against product damage or sticking)
- Ergonomic design (easy to operate and reduce working intensity)

### Sliding Shoe Sorter System Composition

- Merge infeed conveyors + Main line conveyor + Accelerating conveyor to space products + Barcode scanner + Sliding Shoe Sorter + Outfeed conveyors (chute) etc.

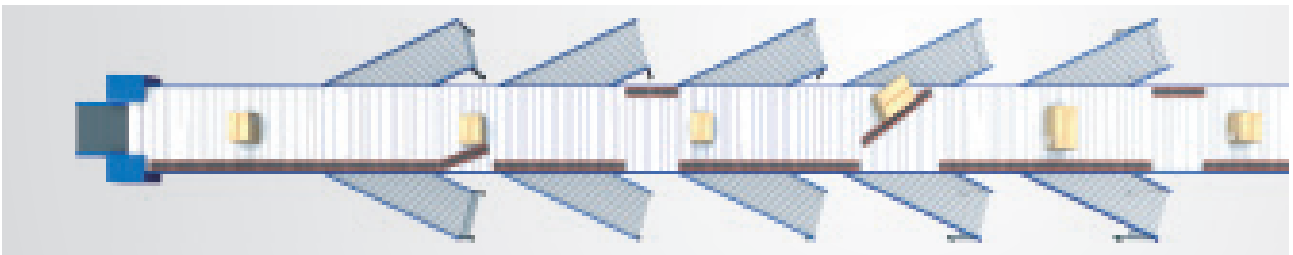

## Production of Sliding Shoe Sorter

Production in factory

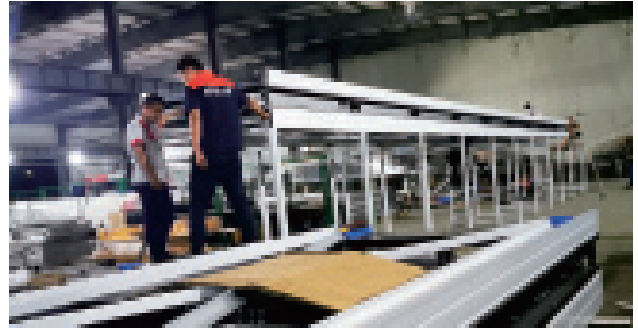
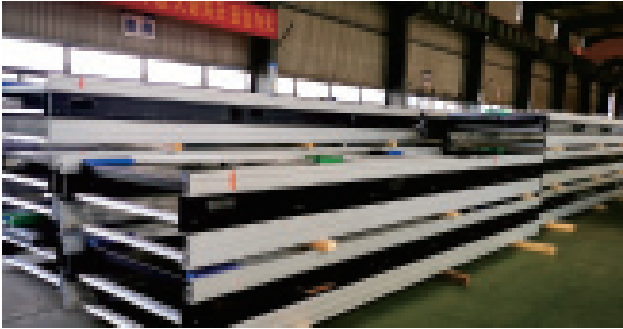

Performance test



Commissioning at factory



# Sliding Shoe Sorter



## APOLLO Slide Shoe Sorter Installation and Commission

### Installation and Delivery

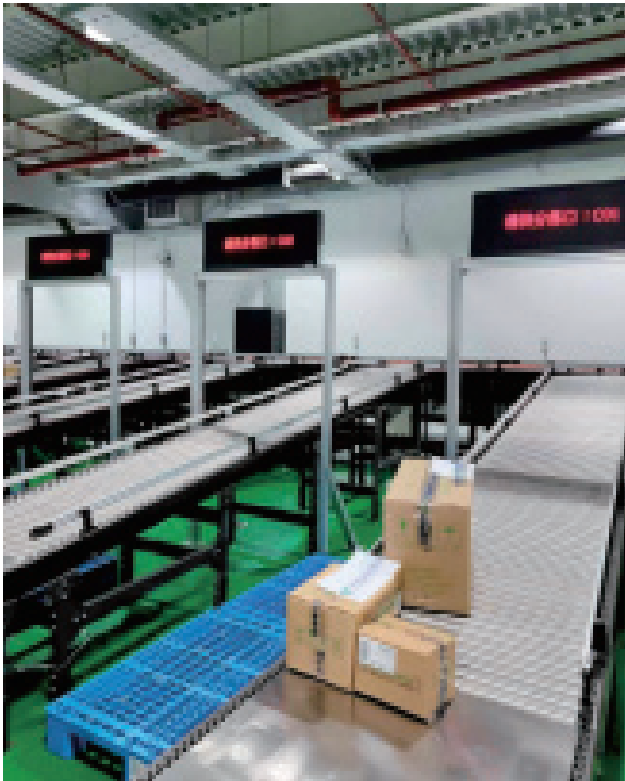

## Application of Sliding Shoe Sorter

---



## Application of Sliding Shoe Sorter

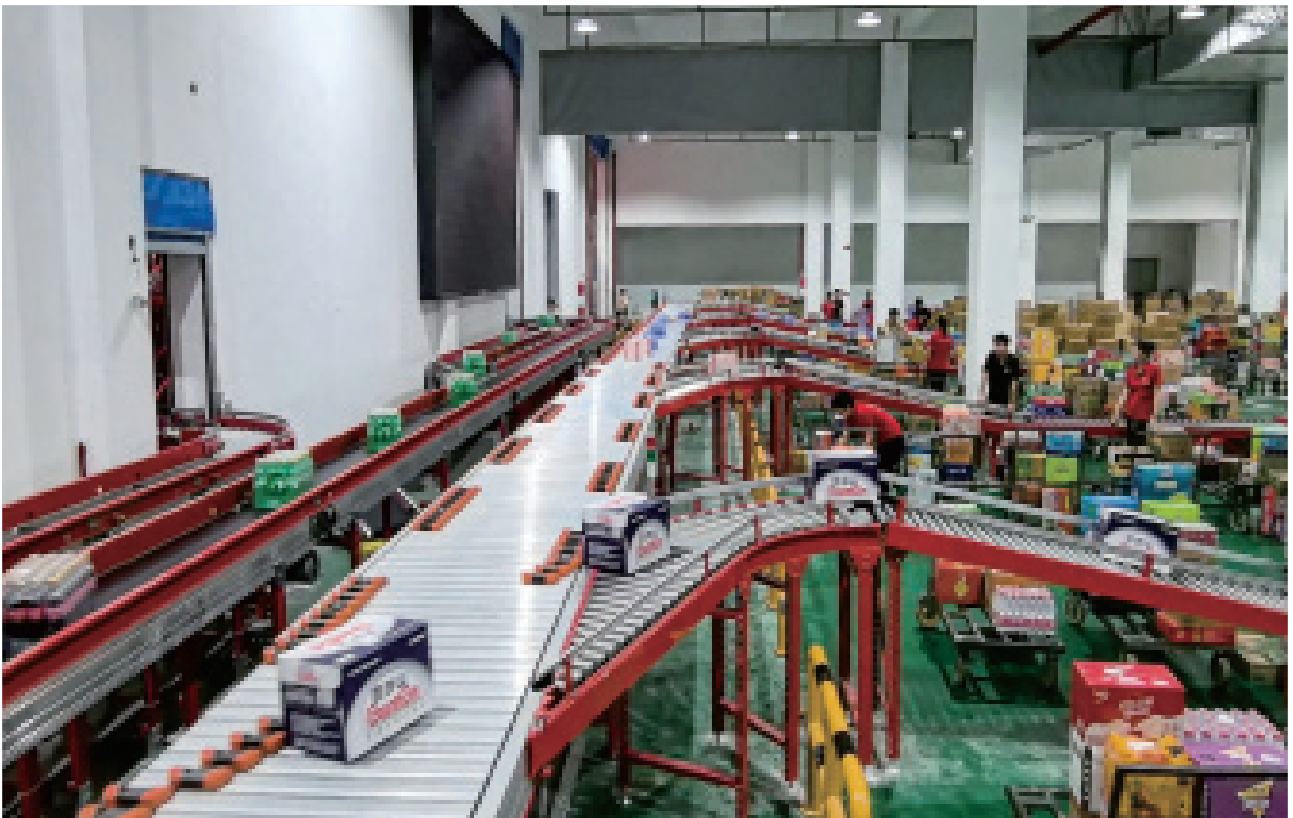

# Steerable Wheel Sorter



Product introduction:  
See P.75-77 for details



Scan QR code on WeChat to  
watch video

# Steerable Wheel Sorter



## APOLLO Steerable Wheel Sorter Selection

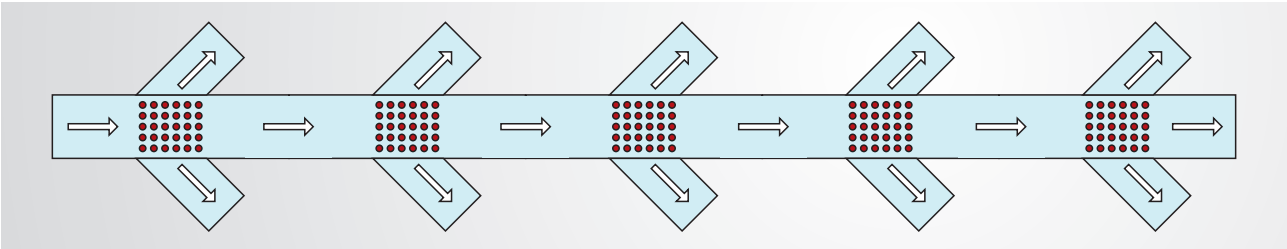

Technical Parameters	
Parameter name	Steerable Wheel Sorter
Equipment width	500mm / 600mm / 700mm / 800mm
Steering method	Servo electric / pneumatic
Runspeed	≤90 m/min
Sorting angle	±30°
Sorting efficiency	≤4000 products/hour (depending on the specifications of goods)

### Application range

- E-commerce, fast-moving consumer goods, pharmaceuticals, clothing, food, tires, 3C electronics etc.

### Applicable Products

- Cartons, turnover boxes, tires, packages etc.

## APOLLO Steerable Wheel Sorter Application



# Pop-up Sorter



Product introduction:  
See P.78-79 for details



Scan QR code on WeChat to  
watch video

## APOLLO Pop-up Sorter Selection

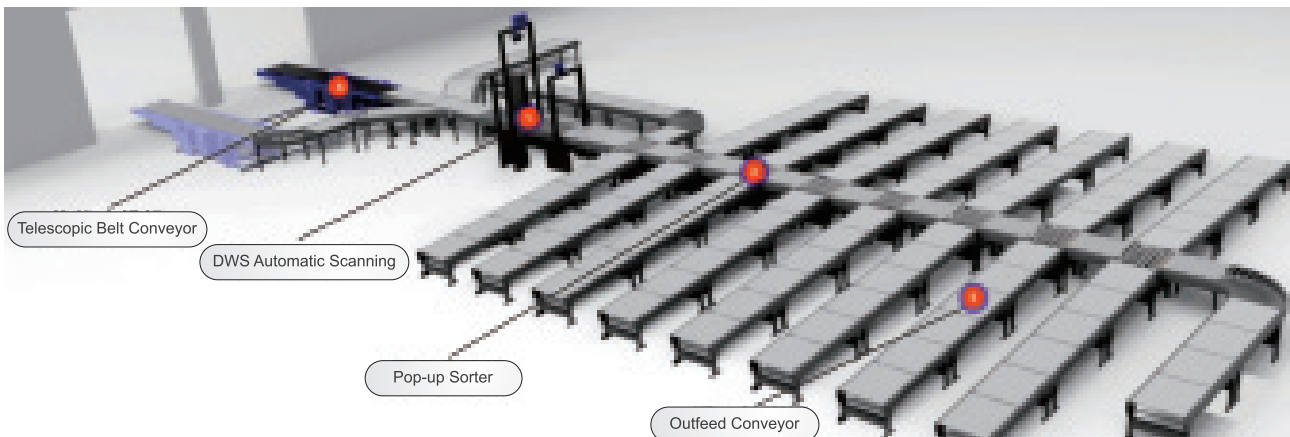

### Technical Parameters

Parameter name	Pop-up Sorter
Equipment width	400mm / 500mm / 600mm / 700mm / 800mm
Steering method	Electric lifting and transferring
Run speed	≤60 m/min
Sorting Angle	±90°
Sorting efficiency	≤2000 products/hour (depending on the specifications of goods)
Sorting product	Cartons, turnover boxes, barrels, tires, etc.

# Mini Picking Sliding Shoe Sorter



Product introduction:  
See P.80-82 for details



Scan QR code on WeChat to  
watch video

## APOLLO Mini Picking Sliding Shoe Sorter Selection



### Types of products that can be sorted

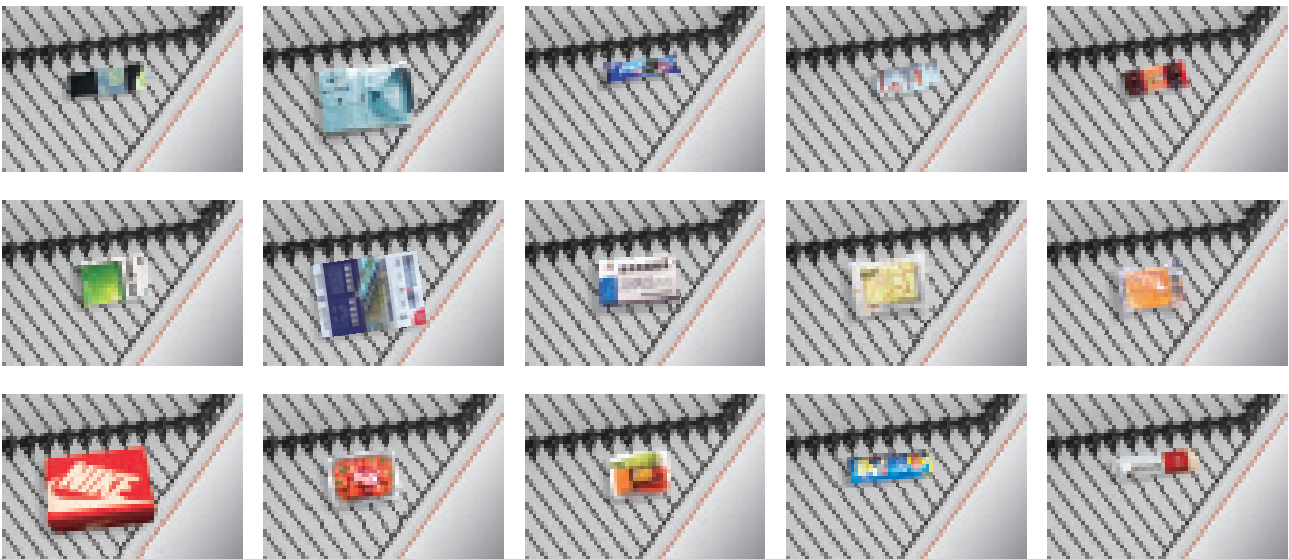

Technical Parameters	
Parameter name	Mini Picking Sliding Shoe Sorter
Equipment function	Picking by order
Equipment length	10m - 100m
Output exit spacing	800mm
Number of outputs	≤220 orders/unit
Equipment height	800m-1400mm can be customized
Sorting efficiency	≤6000 products/hour
Cargo specifications	Max : 400×300×250mm      Min : 50×50×5mm
Cargo weight	50g-15kg
Equipment material	Aluminum alloy

## APOLLO Mini Picking Sliding Shoe Sorter Application

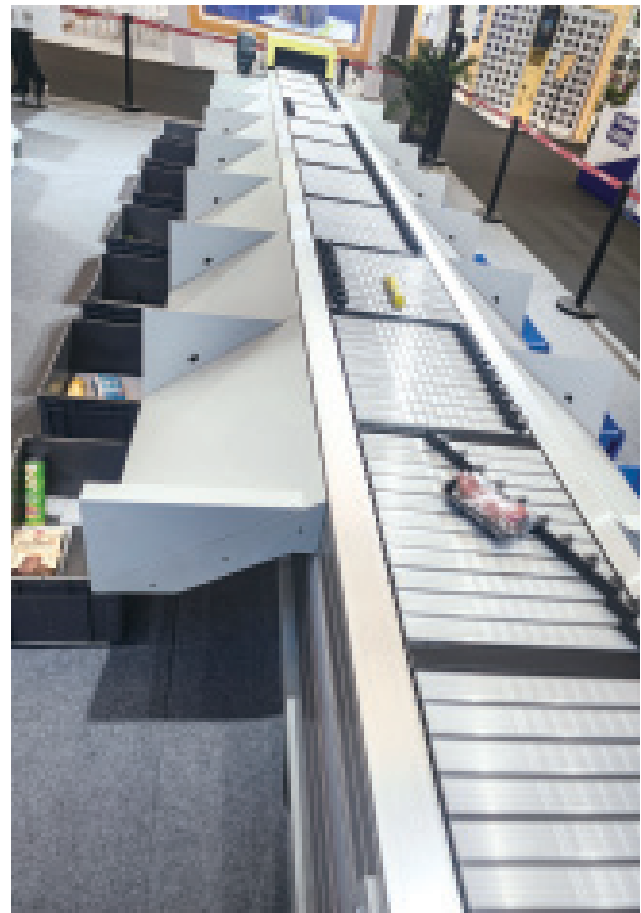

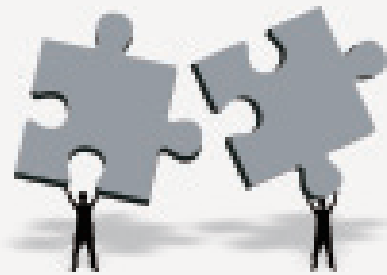

APOLLO

More products  
to come...

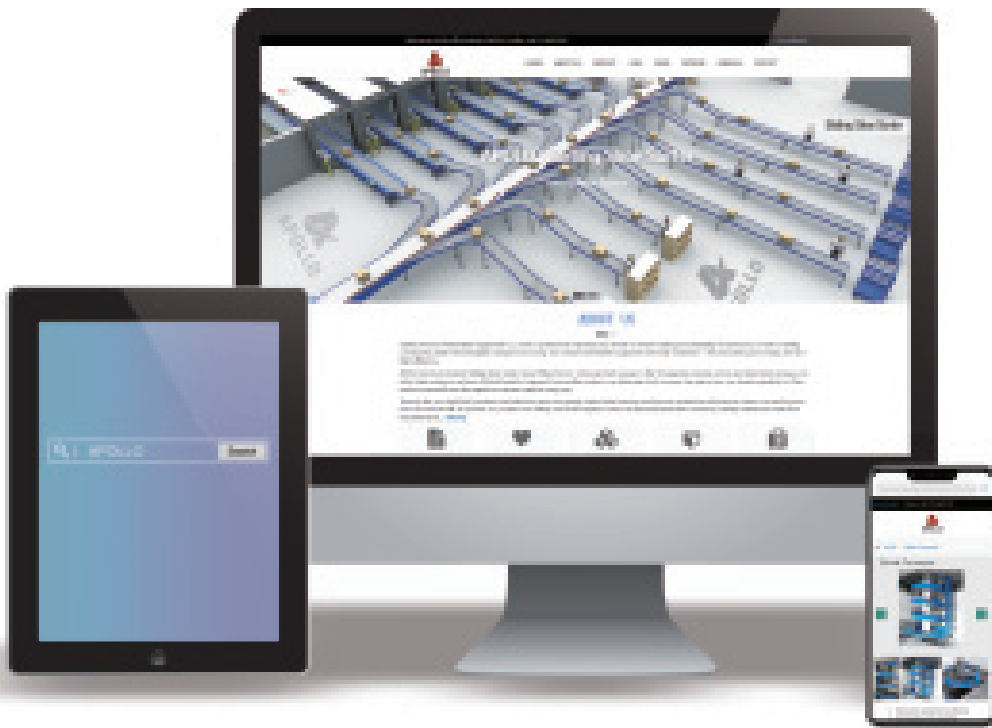

# Suzhou APOLLO Automation Equipment Co., Ltd.



Consulting  
Contact



Scan to Get  
Information



WeChat Video



+86-512-6631 3185



+86-151 5140 8535 Amy



No. 5527, Wuzhong Avenue, Wuzhong District, Suzhou City,  
Jiangsu Province, China



[amy@sz-apollo.com](mailto:amy@sz-apollo.com)

[www.sz-apollo.com](http://www.sz-apollo.com)